

# MX3242X

# EUROACK®

## User's Manual

Version 1.2 May 2001

ENGLISH

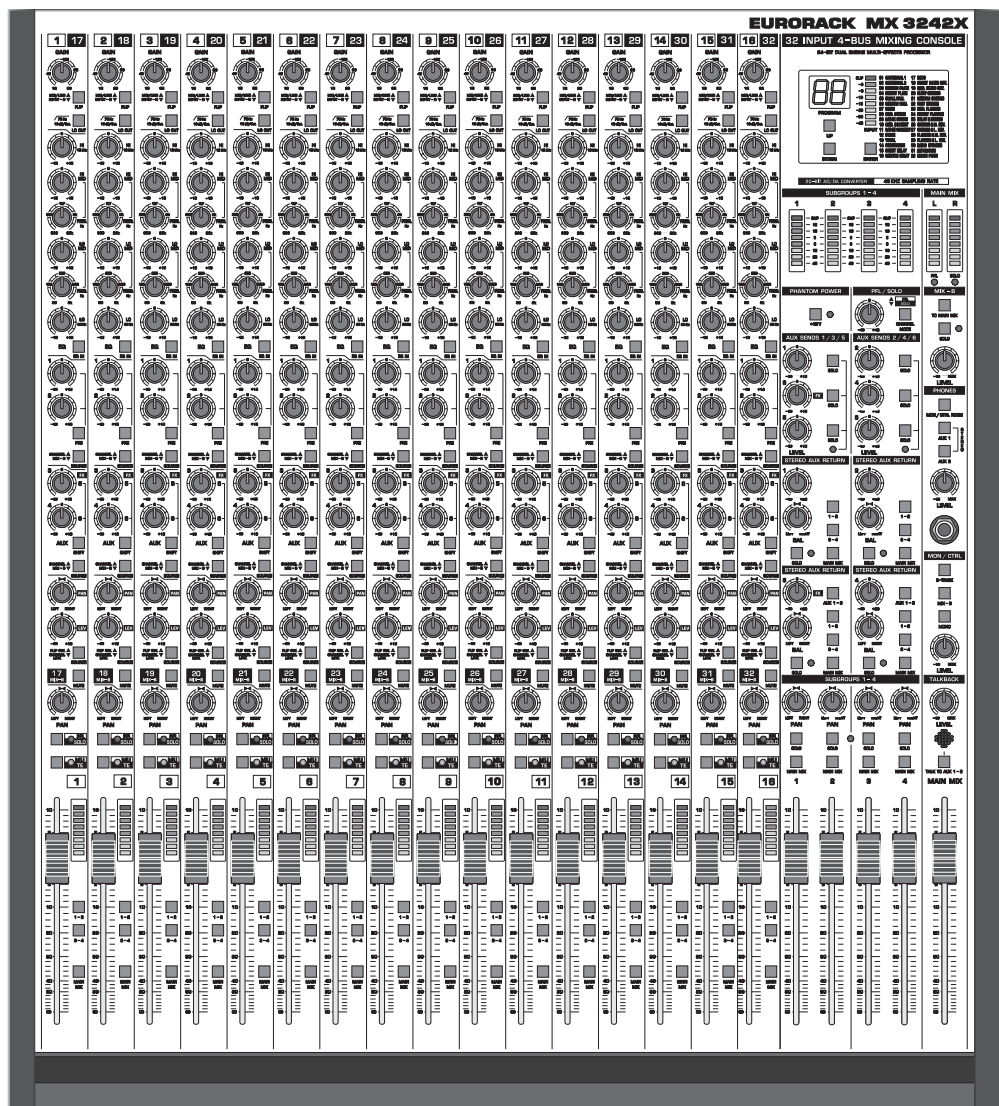

## SAFETY INSTRUCTIONS

**CAUTION:** To reduce the risk of electric shock, do not remove the cover (or back). No user serviceable parts inside; refer servicing to qualified personnel.



**WARNING:** To reduce the risk of fire or electric shock, do not expose this appliance to rain or moisture.



This symbol, wherever it appears, alerts you to the presence of uninsulated dangerous voltage inside the enclosure—voltage that may be sufficient to constitute a risk of shock.



This symbol, wherever it appears, alerts you to important operating and maintenance instructions in the accompanying literature. Read the manual.

### DETAILED SAFETY INSTRUCTIONS:

All the safety and operation instructions should be read before the appliance is operated.

#### **Retain Instructions:**

The safety and operating instructions should be retained for future reference.

#### **Heed Warnings:**

All warnings on the appliance and in the operating instructions should be adhered to.

#### **Follow instructions:**

All operation and user instructions should be followed.

#### **Water and Moisture:**

The appliance should not be used near water (e.g. near a bathtub, washbowl, kitchen sink, laundry tub, in a wet basement, or near a swimming pool etc.).

#### **Ventilation:**

The appliance should be situated so that its location or position does not interfere with its proper ventilation. For example, the appliance should not be situated on a bed, sofa, rug, or similar surface that may block the ventilation openings, or placed in a built-in installation, such as a bookcase or cabinet that may impede the flow of air through the ventilation openings.

#### **Heat:**

The appliance should be situated away from heat sources such as radiators, heat registers, stoves, or other appliances (including amplifiers) that produce heat.

#### **Power Source:**

The appliance should be connected to a power supply only of the type described in the operating instructions or as marked on the appliance.

#### **Grounding or Polarization:**

Precautions should be taken so that the grounding or polarization means of an appliance is not defeated.

#### **Power-Cord Protection:**

Power supply cords should be routed so that they are not likely to be walked on or pinched by items placed upon or against them, paying particular attention to cords and plugs, convenience receptacles and the point where they exit from the appliance.

#### **Cleaning:**

The appliance should be cleaned only as recommended by the manufacturer.

#### **Non-use Periods:**

The power cord of the appliance should be unplugged from the outlet when left unused for a long period of time.

#### **Debris and Liquid Entry:**

Care should be taken that debris and/or liquids do not enter the enclosure through openings.

#### **Damage Requiring Service:**

The appliance should be serviced by qualified service personnel when:

- The power supply cord or the plug has been damaged; or
- Debris or liquid has entered the appliance; or
- The appliance has been exposed to rain; or
- The appliance does not appear to operate normally or exhibits a marked change in performance; or
- The appliance has been dropped, or the enclosure damaged.

#### **Servicing:**

The user should not attempt to service the appliance beyond that which is described in the operating instructions. All other servicing should be referred to qualified service personnel.

## FOREWORD

Dear Customer,

Welcome to the team of EURORACK users and thank you very much for expressing your confidence in BEHRINGER products by purchasing this unit.

It is one of my most pleasant tasks to write this letter to you, because it is the culmination of many months of hard work delivered by our engineering team to reach a very ambitious goal: To produce a compact mixer, which fully satisfies your and our expectations and delivers a superior sound quality, easy operation and technical specifications. In addition to that the mixer is affordable for almost every musician. The task to design the EURORACK certainly meant a great deal of responsibility, which we assumed by focusing on you, the discerning user and musician. It also meant a lot of work and night shifts to accomplish this goal. But it was fun, too. Developing a product usually brings a lot of people together, and what a great feeling it is when everybody who participated in such a project can be proud of what we've achieved.

It is our philosophy to share our joy with you, because you are the most important member of the BEHRINGER family. With your highly competent suggestions for new products you've greatly contributed to shaping our company and making it successful. In return, we guarantee you uncompromising quality (manufactured under ISO9000 certified management system) as well as excellent technical and audio properties at an extremely favorable price. All of this will enable you to fully unfold your creativity without being hampered by budget constraints.

We are often asked how we can make it to produce such high-grade devices at such unbelievably low prices. The answer is quite simple: it's you, our customers! Many satisfied customers means large sales volumes enabling us to get better conditions of purchase for components, etc. Isn't it only fair to pass this benefit back to you? Because we know that your success is our success, too!

I would like to thank all people whose help on "Project EURORACK MX3242X" has made it all possible. Everybody has made very personal contributions, starting from the designers of the unit via the many staff members in my company to you, the user of BEHRINGER products.

My friends, it's been worth the trouble!

Thank you very much,

A handwritten signature in black ink, appearing to read 'U. Behringer', with a long horizontal flourish extending to the right.

Uli Behringer

# EURORACK®

**Ultra-low noise 16/32-channel 4-bus inline mixing console with integrated VIRTUALIZER multi-effects processor.**

- ▲ 16 microphone input channels with gold-plated XLRs, TRS jacks, inserts and direct outputs
- ▲ Ultra-low noise discrete mic preamps with +48 V phantom power and switchable low cut filter
- ▲ 16 Line input channels with balanced TRS jack connectors
- ▲ 4 subgroups with independent pan control, solo and main mix switches and inserts
- ▲ 4 stereo aux returns with separate level and pan controls, solo and routing switches
- ▲ 2 pre / post and 4 post fader aux sends for a maximum effects and monitoring flexibility
- ▲ 6 master aux sends with gain control and solo switches
- ▲ 24-bit stereo multi-effects processor with ultra-high resolution 46 kHz, 20-bit AD/DA converters
- ▲ 32 original VIRTUALIZER presets including 16 different reverbs, delays, chorus, flanger, pitch shifter, speaker simulation and various combinations
- ▲ Extremely high headroom – offering a huge dynamic range
- ▲ Balanced inputs and main outputs for highest signal integrity
- ▲ Ultra-musical and original EURODESK 4-band EQ with two sweepable mids and I/O switch on all channels
- ▲ LED controlled mute, solo-in-place / pre-fader-listen function on all channels
- ▲ Mix-B section with separate level and pan controls, mute and source switches
- ▲ Separate main mix, control room and headphone outputs
- ▲ Extremely versatile headphone and talkback section
- ▲ Highly accurate 8-segment bargraph meters on all channels, subgroups and main mix
- ▲ Ultra-high quality 100 mm faders for all channels, subgroups and main mix
- ▲ 19 inch rack mounting kit included
- ▲ Professional 19 inch external power supply ensures superior transient response
- ▲ State-of-the-art 4580 ICs and high quality components ensure crystal-clear audio performance
- ▲ Extremely rugged construction ensures long life even under the most demanding conditions
- ▲ Manufactured under ISO9000 certified management system

---

# TABLE OF CONTENTS

<b>1. INTRODUCTION</b> .....	<b>7</b>
1.1 Concept .....	7
1.1.1 Architecture .....	7
1.2 Before you start .....	8
1.2.1 Level meters .....	8
1.2.2 Power Supply Unit (PSU) .....	9
1.2.3 Warranty .....	9
1.2.4 Shipping .....	9
1.2.5 Mounting the MX3242X in a rack .....	10
<b>2. OPERATION</b> .....	<b>10</b>
2.1 Main input channel .....	10
2.1.1 Input level setting .....	11
2.1.2 Equalizer .....	12
2.1.3 Aux Send buses .....	12
2.1.4 Routing, fading and muting .....	13
2.1.5 FLIP switch .....	14
2.2 Mix-B input channel .....	14
2.2.1 Input level setting .....	14
2.2.2 Aux Send buses .....	14
2.2.3 Routing .....	15
2.3 Insert points and direct outputs .....	15
2.3.1 Main input channels .....	16
2.3.2 Subgroups .....	16
2.3.3 Main mix .....	16
2.3.4 Direct output on each Main input channel .....	16
2.4 Main section .....	17
2.4.1 Aux Send buses .....	17
2.4.2 Aux Returns – additional stereo line inputs .....	17
2.4.3 Level meters .....	18
2.4.4 CHANNEL MODE and SOLO MASTER LEVEL controls .....	18
2.4.5 Mix-B .....	18
2.4.6 Monitor section .....	19
2.4.7 Headphones section .....	19
2.4.8 Subgroups and Main Mix fader .....	20
2.4.9 Digital Effects Processor .....	20
2.4.10 Talkback facility: communicating with performers in the studio .....	22
<b>3. PRACTISE</b> .....	<b>23</b>
3.1 Selecting inputs .....	23
3.2 Initializing channels for gain setting .....	23
3.3 Auditioning a signal and setting up a channel .....	23
3.4 Desk normalization .....	23
3.5 Multi-track initialization .....	23
3.6 Recording levels .....	23
3.7 Track sheet .....	24

<b>4. APPLICATIONS .....</b>	<b>24</b>
4.1 Recording situation .....	24
4.2 Live situation .....	25
4.3 Patchbay .....	26
4.3.1 Patchbay configuration .....	26
4.3.2 Parallel .....	26
4.3.3 Half-normalled .....	26
4.3.4 Normalled .....	27
4.3.5 Open .....	27
4.3.6 Patchbay organization .....	27
4.3.7 Looming problems .....	29
4.4 Expanding the MX3242X .....	29
4.4.1 Expander Port .....	29
4.4.2 Modifications .....	30
<b>5. TECHNICAL BACKGROUND .....</b>	<b>33</b>
5.1 Mixing .....	33
5.1.1 Equalization .....	33
5.1.2 Gain optimization .....	34
<b>6. INSTALLATION .....</b>	<b>34</b>
6.1 Rack mounting .....	34
6.2 Mains connection .....	35
6.3 Audio connections .....	35
<b>7. APPENDIX .....</b>	<b>37</b>
7.1 Specifications .....	37
7.2 Track sheet .....	38
<b>8. WARRANTY .....</b>	<b>39</b>

## 1. INTRODUCTION

Congratulations! In purchasing the BEHRINGER EURORACK MX3242X you have acquired a mixing console whose compact size belies its incredible versatility and superlative audio performance. Your EURORACK is built to the same outstanding quality as our top-of-the-range console, the BEHRINGER EURODESK MX9000. With its 19", 12 HU size it fits in a standard rack. When you mount the side panels, you can also use it as a table-top model. The interface panel on the rear can be rotated easily and thus gives you convenient access to all connectors, even when the MX3242X is installed in a rack.

With its complete range of sophisticated routing options, the EURORACK MX3242X is a perfect tool for both live and studio applications. Various modifications enable you to customize the console to suit your specific requirements. You can use the EURORACK as a recording or live console, as a live console with simultaneous multi-track recording facilities, as a sub-mixer, surround mixer, etc.

Another outstanding feature of your MX3242X is its on-board digital 24-bit Effects Processor. We designed a scaled-down version of our well-known VIRTUALIZER, which nevertheless has the same 20-bit AD/DA converters, 24-bit DSP, 46 kHz sample rate and algorithms as our 19" unit. Which means, you can choose from 32 presets with first-class Reverb, Delay and modulation effect algorithms.

Below in this handbook you'll find some information on how to enhance the console's functionality even further by using the Expansion Port to feed additional line signals in your MX3242X. At the moment, we are planning an expansion module that can be used both as a stand-alone rack mixer and as an expansion to your MX3242X making it a future-oriented and upgradable mixing console that grows with your needs. First of all, however, we'd like to take you on a guided tour of all the "sights" of your BEHRINGER EURORACK MX3242X.

We recommend that you experiment with your EURORACK away from the pressure of a recording session or live concert, in order to get a feel for it. After all, it's a musical instrument. Learn to play it well.

Most specialist subjects are not really as difficult as they may seem at first – provided you understand the language used. The vocabulary of mixing is pretty straightforward: a "slot" in a recorder will always be referred to as a "track", while that in a mixer is a "channel". We will try to be as unambiguous as possible with terms, since much confusion can arise from sloppy definitions.

On a separate sheet you will find some drawings showing all control elements and a block diagram respectively. All control elements will be numbered consistently throughout the manual, whether they be in the text or on an illustration.

### 1.1 Concept

The EURORACK MX3242X is a cross between "split" and "inline" designs. The input channels are located in the larger left-hand section of the console, while the outputs to a multi-track recorder can be found on the right (Subgroups). In contrast to conventional "split" consoles, however, the Tape Returns coming from the multi-track recorder (feeding the tape signal back to the mixer) are not located in the outputs section but are integrated in the input channels (as it is typical of an "inline" console). Thus, the input channel functions can also be used for the Tape Returns. And later, during the mixdown this design ensures a signal path that is as short as possible.

The MX3242X is configured as a 32/16 in 4 in 2 console, i.e. you have 16 input channels, 4 Subgroups and 16 monitor inputs for the Tape Returns. You can use one Main Mix, 4 Subgroup and 16 channel faders, each with a control range of 100 mm. Since the monitor channels (called Mix-B in the following) can be routed to the Main Mix bus, you can use 32 channels during mixdown. With the 6 Aux Returns and 4 Subgroups (which can be fed via their insert points using a special cable), you have a total of 42 channels available.

On the EURORACK MX3242X you can control 6 Aux buses with 4 rotary controls. Aux buses 1 and 2 are used for monitor mixes, and the talkback facility ensures straightforward communication between engineer and artist. For live applications you can use the Mix-B bus as an additional monitor bus, and the 4 mono post-fader Aux buses to drive external effects devices.

The input/output section comprises Microphone inputs (with 48 V phantom power), Line inputs, multi-track connectors, various insert points as well as connectors for a 2-Track master recorder (e.g. DAT) and a monitor system (monitor speaker with power amp).

### 1.1.1 Architecture

#### Main input channels

Channels 1 through 16 are configured as mono channels with balanced Microphone and Line connectors. The discrete “vintage”-type microphone preamps in high-current technology have the same excellent quality as the amplifiers in our legendary BEHRINGER EURODESK MX9000. An overdimensioned external 19" power supply unit eliminates hum interference and ensures perfect pulse response even with signal transients. The insert jacks give the Main input channels a similar functionality as can be found in “big” mixing consoles.

#### Mix-B input channels

The MX3242X provides another 16 Line inputs whose operating level can be switched between +4 dBu and -10 dBV, making these inputs ideally suited for use as multi-track Tape Returns or to connect MIDI and other electronic devices.

#### Subgroups

The four Subgroups can be used to feed signals to a multi-track recorder. In live applications they also allow for combining several instruments, control their volumes with just *one* fader and send the resulting sub-mix signal to the Main Mix bus.

#### Channel outputs

The channel signal passes a high-grade logarithmic 100-mm fader, to be routed to the Subgroups and/or the Main Mix bus.

#### Aux Sends

The MX3242X features 6 Aux Send buses (2 pre/post, 4 post-fader), which can receive their signals both from the Main channel and from the Mix-B input. The third Aux Send is marked “FX” and is routed to the console’s on-board multi-effects processor, but can also be used for external effects devices.

#### Stereo Aux Returns (additional stereo Line inputs)

The MX3242X is equipped with 4 stereo Aux Returns located above the Subgroups. The inputs can be used as stereo effect return or additional Tape Return inputs. As an alternative, you can also connect MIDI instruments. The third Aux Return carries the signal from the on-board effects processor, however, can also be used as an additional Line input, so that the outputs of the on-board effects device are not routed to Aux Return 3.

#### Main Mix output (“master”)

The MX3242X has an extremely high-grade logarithmic 100-mm stereo fader to control the level of the master outputs.

#### 24-bit digital Effects Processor

The on-board 24-bit digital Effects Processor features first-class algorithms, similar to those used in our VIRTUALIZER, and offers all standard effect types such as Reverb, Chorus, Flanger, Delay, etc. With its excellent audio quality it can be used both for mixdowns, live concerts and monitoring.

Other highlights of the MX3242X are: an adjustable headphones output (stereo headphones mix possible!), a separate 2-Track in/output as well as the Expansion Port mentioned above. Insert points are available on the Main channels, Subgroups and Main Mix bus. Additionally, each Main channel has a direct output which can be modified. Thus, the MX3242X can handle up to 20 tracks in a multi-track environment by adding the Aux Return inputs and routing them to the Subgroups. And all this in a compact enclosure of 19" and 12 HU. So, there is no reason why you shouldn't use your EURORACK for mobile applications, too.

## 1.2 Before you start

### 1.2.1 Level meters

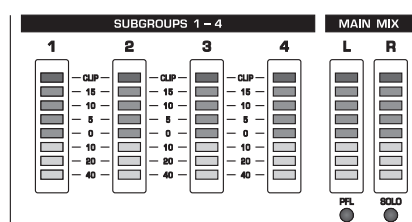



Fig. 1.1: Subgroup and Main Mix level meters



Each of the Main input channels, the Subgroups and the Main Mix bus are equipped with 8-segment, 3-color LED level meters ([26], [34] and [53]), which help you set levels correctly and avoid distortion. When your MX3242X is shipped from the factory, the level meters are configured post-fader, but can also be modified to display pre-fader signals (cf. 4.4.2 Modifications).

The level meters should average around 0 dB during loud passages. If they read persistently higher, or are peaking above +10 dB, you should move the faders down a bit. As a last resort you can also reduce the input gain in the channels. Always work with the PFL function and make sure that the red CLIP LED in the level meters won't light up.

 **When you activate the MUTE switch, the level meters in the main input channels offer you two helpful functions: If a signal is present in the main input channel, the lowest green LED lights up (signal present). If the gain setting is too high, the red CLIP LED on top of the channel level meter lights up. So you are able to control the main input channel's signal, even when the MUTE switch is activated.**

### 1.2.2 Power Supply Unit (PSU)

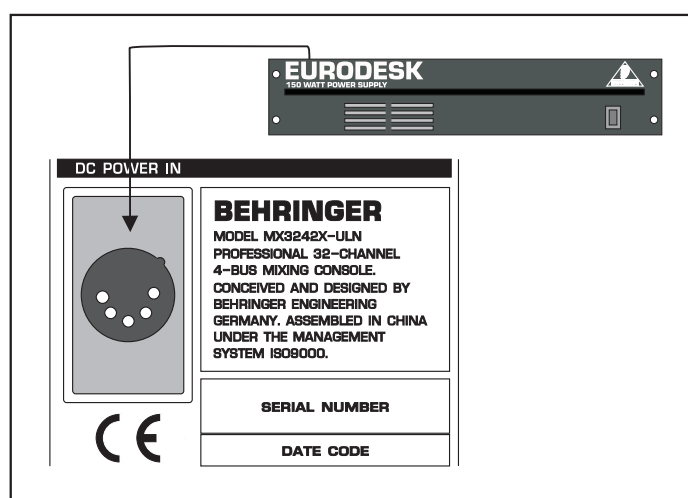

Fig. 1.2: Connecting the Power Supply

Any amplifier circuit is limited in its transient response by the available current. Every mixer has numerous operational amplifiers (op-amps) inside to process line level signals. When being driven hard, many desks begin to show signs of stress due to power supply limitations. Not so with the EURORACK: the sound will always stay clean and transparent right up to the operating limits of the op-amps themselves, thanks to the overdimensioned external 150-W PSU. Mounted in a 19" enclosure (2 ½ rack units), the EURORACK's PSU is connected on the rear with a multi-pin connector. However, you should make sure that 3 HU are available to ensure proper airflow around the heat sinks.

Please connect the Power Supply to the PSU connector (Power Supply Unit) [70] on the rear of your EURORACK MX3242X before you connect it to the mains.

 **Never connect the PSU to the EURORACK while the PSU is connected to the mains supply!**

 **Only use the enclosed power cord to connect the PSU to the mains.**

### 1.2.3 Warranty

Please ask your specialized retailer to fill in the warranty card, then send it back to us within 14 days after the date of purchase. Otherwise you will lose your extended warranty rights. The serial number [90] of your MX3242X can be found on the rear of the console. Or use our online registration option available on the Internet at [www.behringer.com](http://www.behringer.com).

### 1.2.4 Shipping

Your EURORACK MX3242X was carefully packed in the factory and the packaging was designed to protect the unit from rough handling. Nevertheless, we recommend that you carefully examine the packaging and its contents for any signs of physical damage, which may have occurred in transit.

**👉 If the unit is damaged, please do not return it to us, but notify your dealer and the shipping company immediately. Otherwise claims for damage or replacement may not be granted.**

### 1.2.5 Mounting the MX3242X in a rack

In the shipping carton you'll find two 19" mounting angles which can be fixed to the side panels of the console. Remove the side panels by loosening the screws (3 per side) that fix them to the console, lay the panels aside and use the screws to fasten the mounting angles. Please note that each angle can be mounted on a specific side only.

To be able to reach the rear connectors when the MX3242X is mounted in a rack, you should rotate the interface panel by 90° (after loosening the screws holding it), and refix it. The following screws must be removed:

- 1) 4 screws on the upper part of the interface panel.
- 2) Another 4 screws on the cover plate directly mounted to the interface panel at an angle of 90°.
- 3) 6 screws each on the left and right side panels.

Once the interface panel has been rotated, please check that all ribbon cables are seated and connected properly. Then tighten all screws.

**👉 Ensure sufficient air space around the MX3242X. Never mount the unit in close proximity to a power amp or similar device to avoid overheating.**

**👉 Please note that both PSU and EURORACK will heat up during operation. This is completely normal and does not indicate a malfunction.**

## 2. OPERATION

### 2.1 Main input channel

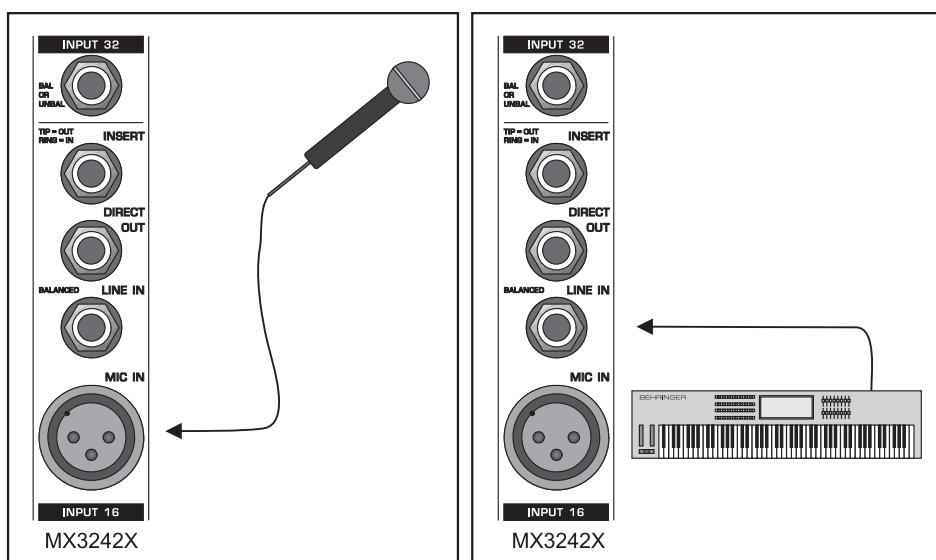

Fig. 2.1: Connecting a signal source to a Main input channel

Each mono channel features a balanced Line input on a ¼" jack [88] and a balanced Microphone input on an XLR connector [89].

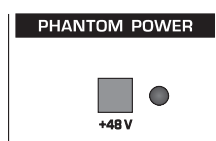

Fig. 2.2: Phantom power switch

The +48 V phantom power required for condenser mics can be activated with the phantom power button [37] in the Main section. If activated, the LED next to the button lights up.

**⚠️ Mute the sound system before you turn on phantom power. Otherwise, power-up thumps could be played back by the monitor speakers.**

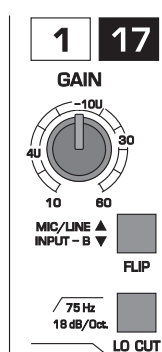

Fig. 2.3: Gain control and Lo Cut filter

The Gain control [1] has a very wide range, obviating the need for Mic/Line switching. The levels most commonly used are -10 dBV and +4 dBu, and are clearly labelled.

**⚠️ Please note that you can only use either of the Mic and Line inputs, but never both at the same time!**

### 2.1.1 Input level setting

Channel input level is determined by the Gain control [1]. Use the PFL/SOLO button [24] to bring the left and right portions of the input signal onto the level meters [53] in the Main section. This also sends the SOLO/PFL-signal to the speakers.

For overall level setting you should use the mono PFL bus rather than the post-fader and post-channel-pan SOLO bus. Make sure that the CHANNEL MODE button [35] is not pressed. We recommend that you set the level potentiometer [36] for the PFL/SOLO function to 0 dB (12 o'clock). In loud environments (e.g. live application), you can of course raise the PFL/SOLO volume as required.

**⚠️ Please note that too high a monitoring level can lead to hearing damage.**

Using the PFL/SOLO function does not affect the signal that is supplied by the recording outputs, and the same applies to the Aux buses.

In addition to channel level metering in the Main section, each single channel has its own LED chain indicating the level of the post-fader channel signal (see section 1.2.1). This option allows you to detect and correct excessive or insufficient levels quickly, even without having to activate the PFL/SOLO function.

The Lo Cut filter [3] with its high slope of 18 dB/Oct. (-3 dB at 75 Hz) eliminates unwanted subsonics.

### 2.1.2 Equalizer

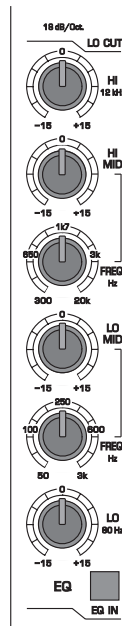

Fig. 2.4: Equalizer

In addition to the Lo Cut filter, all Main input channels come with a 4-band Equalizer with two tunable midrange bands, each having up to 15 dB of cut and boost. In center detent position the EQ is “off”. With the EQ IN button **10** you can activate/bypass the Equalizer, so as to allow for easy comparisons of EQ-ed and unprocessed signals. If you don’t use the Equalizer, don’t press the EQ IN button.

The HI and LO bands work with shelving-type filters raising or lowering all frequencies beyond the selected value. The cutoff frequencies of the HI **4** and LO **9** bands are 12 kHz and 80 Hz respectively. In the midrange band, the MX3242X provides two tunable peaking-type filters emphasizing the center frequency with a filter quality of one octave. The HI MID band can be tuned from 300 Hz through 20 kHz, the LO MID band from 50 Hz through 3 kHz. Use controls 6 and 8 to select the center frequencies of the two midrange bands, and controls 5 and 7 to determine cut/boost.

### 2.1.3 Aux Send buses

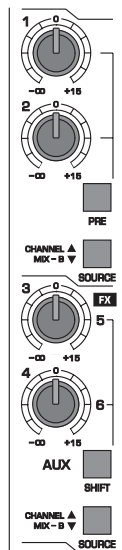

Fig. 2.5: Aux Sends

All Aux Sends are mono, post-EQ and post-mute. To make sure that the signal from the Main input channel is sent to the Aux bus, SOURCE buttons [14] and [18] should be up (not pressed). However, you can also split the Aux buses and use them both for the Main input channel and for the Mix-B channel. Aux Sends 1 [11] and 2 [12] can be set either pre or post-fader using button [13], while Aux Sends 3 through 6 are always post-fader. Aux Sends 3 and 4 as well as 5 and 6 are controlled by potentiometers [15] and [16]. The SHIFT button [17] determines whether Aux 3 and 4, or 5 and 6 are active. Aux control 3 (marked FX) controls the level sent to the on-board digital Effects Processor. Of course, you can also drive an external effects device from Aux Send 3. Simply use the Aux Send jack 3 and any of the Aux Return inputs on the rear of the MX3242X to connect to the external device. In this case, the on-board Effects Processor does no longer receive a signal from Aux Send 3.

For almost all effect send purposes, you will want Aux Sends to be post-fader, so that when a fader level is adjusted, the effect intensity from that channel follows the fader. Otherwise, when the fader is pulled down, the effect signal from that channel will still be audible. For cueing purposes, Aux Sends will usually be set pre-fader, i.e. independent of the channel fader.

Most effects devices sum internally the left and right inputs. The very few that don't may be driven in true stereo by using 2 Aux Sends.

There is +15 dB of gain on every Aux Send. Such a high boost is usually only appropriate where the channel fader is set around -15 dB or lower. Here, an almost exclusively "wet" signal will be heard. In most consoles, such a wet mix requires the use of a pre-fader setting for channel Aux Send, losing fader control. With the EURORACK you can have a virtually wet mix even in a post-fader configuration, i.e. with total fader control.

The headphones amplifier BEHRINGER POWERPLAY PRO HA4400 gives you a straightforward tool to realize four independent headphone mixes in stereo.

#### 2.1.4 Routing, fading and muting

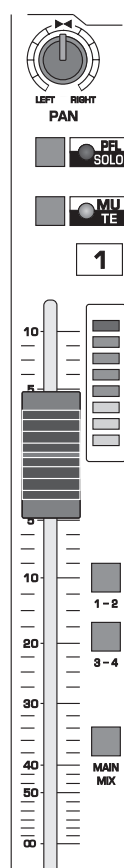

Fig. 2.6: Fader range of Main input channel

Level to the Main mix, Subgroup buses or direct outputs is ultimately determined by the channel faders [27].

These are designed to give a smooth logarithmic taper of a type more usually associated with megabuck consoles. The performance, even at low levels, is far smoother than that of a normal “budget” fader.

The PANORAMA control [23] positions the output of the channel in the stereo field. Its constant-power design ensures there are no level discrepancies whether a signal is hard-panned, center-stage, or somewhere in-between. Such pin-point accuracy will be a revelation if you have been working on consoles with lower quality circuits.

PFL/SOLO we encountered in section 2.1.1. SOLO also follows channel pan.

The MUTE button [25] is ergonomically placed immediately above the channel fader. Engaging MUTE is equivalent to setting a fader level of minus infinity (Main Mix or Subgroup buses), and is indicated by a light-emitting diode.

With the ROUTING buttons [28] you can route the Main input channel either to the Main Mix or one of the four Subgroup buses. For example, if you want to route a signal to Subgroup 3 for recording, simply press routing button “3-4” and turn the PANORAMA control fully to the left.

### 2.1.5 FLIP switch

For recording purposes you will want the Main input channel to process the input signals coming from a microphone, direct-injection box or instrument, while the Mix-B input channel is used to monitor the tracks already recorded. For mixdowns, on the other hand, it would be a great advantage if you had the Equalizer, Aux buses, insert and routing options available via the Subgroups (e.g. to create a drum set sub-mix), so as to process the recorded signals played back by the multi-track recorder. Now, you could re-connect the mono and Mix-B input channels to be able to use the various processing options in the Main input channels for the recorded tracks – a method that is anything but straightforward! The EURORACK MX3242X features a FLIP switch [2] (see fig. 2.3) which simply exchanges the signals of both channels. Thus, the Tape Return signal is routed to the Main input channel, while the Mix-B input channel now carries audio signals, e.g. from MIDI and effects equipment (which usually need less processing than the “raw” signals coming from a multi-track recorder).

## 2.2 Mix-B input channel

The Mix-B input channels are independent secondary channels with their own set of PANORAMA [19] and LEVEL [20] controls. Their output is permanently routed to the Mix-B bus. The sum of all signals from the Mix-B channels can be taken from the MIX-B OUT jacks [74] located on the interface panel. Additionally, you can route the Mix-B bus to the Main Mix bus. More on this in chapter 2.2.3 Routing. Each Mix-B channel has a balanced line-level input on a ¼” phone jack [85]. The operating level (+4 dBu / -10 dBV) can be set globally for all channels by pressing button [93] on the interface panel. In a recording situation you will want to use the Mix-B input channels to return the tracks recorded on a multi-track machine. Here, the OPERATING LEVEL switch helps you adapt the console to the recorder used.

### 2.2.1 Input level setting



Fig. 2.7: OPERATING LEVEL button for Mix-B input channels

The Mix-B channels on the MX3242X are specifically designed for typical line-level signals, in particular, those from Tape Returns. The OPERATING LEVEL switch enables you to adapt the operating level of these inputs (+4 dBu / -10 dBV) to the devices/instruments that are connected to them.

### 2.2.2 Aux Send buses

These are the same as for the main input channels (see 2.1.3). Please note, however, that the SOURCE button of Aux Sends 1 and 2, or 3 through 6 must be pressed to make the respective Aux Sends available to the Mix-B signal.

### 2.2.3 Routing

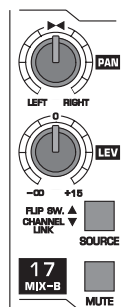

Fig. 2.8: Controlling the Mix-B signal

Each Mix-B input channel has a PANORAMA [19] and LEVEL [20] control as well as a MUTE button [22].

All signals from a Mix-B channel are routed to the Mix-B bus and are available from the MIX-B OUT jack [74] on the interface panel. Their overall volume is determined by the LEVEL control [58] in the MIX-B Main section. Additionally, you can route the Mix-B bus to the Main Mix bus by pressing the TO MAIN MIX button [56].

When you press the SOURCE button [21] in a Mix-B input channel (position: CHANNEL LINK), the channel carries the same signal as the corresponding Main input channel (e.g. Mix-B channel 17 carries the signal of Main input channel 1). The signal is taken post-EQ/post-mute, but pre-fader.

This is the ideal solution whenever two different mixes are required. For example, in a live situation you can create a FOH mix with the Main Mix bus, and use the Mix-B channels to mix down a live recording.

The Mix-B channels can also be used as a pre-fader monitor bus. When mixing a live concert, two monitor paths are often not enough. By activating the SOURCE button in the Mix-B channels, you get an additional pre-fader signal from the Main input channels and can determine the mix of left and right sides with the PANORAMA control. In this way, 4 different monitor mixes can be created (Aux 1, Aux 2, Mix-B left and Mix-B right).

## 2.3 Insert points and direct outputs

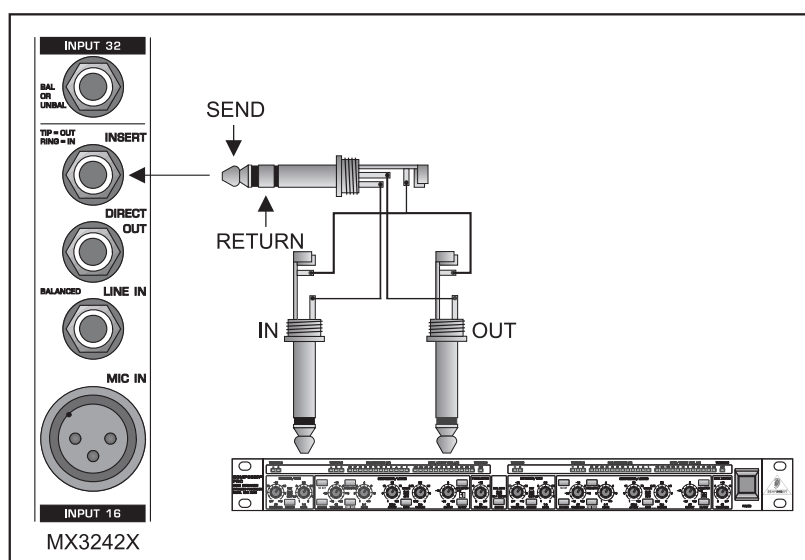

Fig. 2.9: Wiring a Compressor to the insert path of a Main input channel

Insert points are useful for adding dynamic processing or equalization to a channel. Unlike reverbs and other effects devices, which are usually added to the dry signal, dynamic processing is normally applied across an entire signal. Here, an Aux Send bus would be inappropriate. Instead the signal is intercepted somewhere

along the channel, fed through the dynamics processor and/or EQ, then returned to the console at the same point where it left. The insert point is normalized, i.e. the signal is only interrupted when a jack is plugged into it (see chapter 4.3 Patchfield).

### 2.3.1 Main input channels

All main input channels are equipped with insert points (stereo phone jack [86] on the rear). They are configured pre-fader, pre-EQ and pre-Aux Send.

You can extend the functionality of your insert points by wiring them onto a patchfield, where send and return can be accessed on separate sockets (see chapter 4.3).

Additionally, insert points can be used to automate the console functions. Our CYBERMIX CM8000 automation tool is ideally suited for this purpose and can be easily retrofitted via the insert points of your MX3242X.

### 2.3.2 Subgroups

If you want to insert a dynamics processor, etc. into any Subgroup, you can use the Subgroup insert points [79] located on the interface panel.

### 2.3.3 Main mix

The MX3242X features two insert points [73] for the Main Mix bus.

### 2.3.4 Direct output on each Main input channel

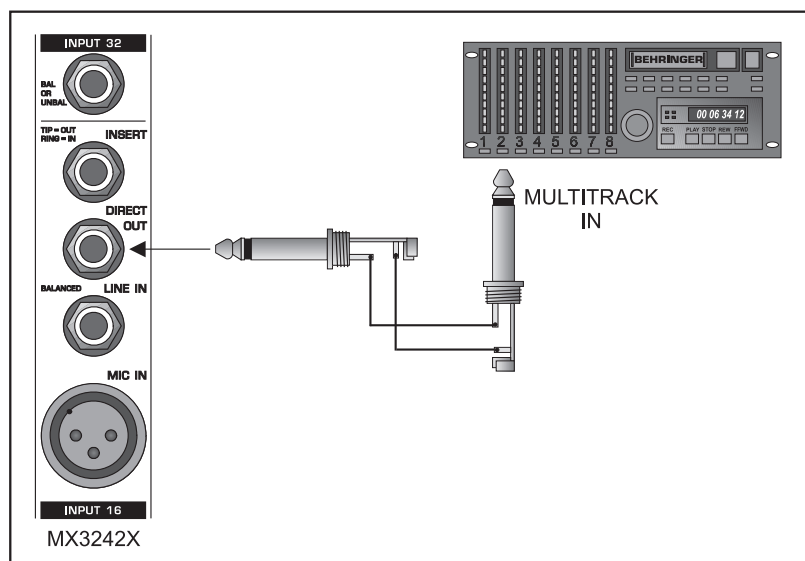

Fig. 2.10: Using the direct outputs for multi-track recording

The MX3242X has four Subgroups which can be used to feed a multi-track recorder. However, it is often necessary to record more than 4 tracks at the same time. For this reason, your EURORACK MX3242X has a **post-fader** direct output [87] for each Main input channel, which allows you to record up to 16 tracks simultaneously.

If that isn't enough, you can also use the various routing options for the Aux Returns to connect line-level signal sources. The signals are routed from there to the Subgroups and ultimately to the multi-track recorder. Of course, you can also create a direct link by fitting a cable with a special 1/4" mono phone plug (tip = ground; sleeve = signal) to feed the signals directly via the inserts to the Subgroups. In this configuration, you can record a maximum of 20 individual signals at the same time ... with a 12 rack units console!



## 2.4 Main section

### 2.4.1 Aux Send buses

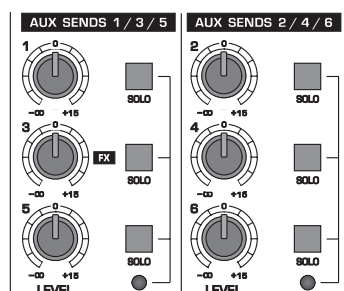

Fig. 2.11: Aux Send Main section

Aux Sends are on ¼" phone jacks [80]. Their level can be adjusted with the master controls for Aux Sends 1 through 6 [39] located in the Main section. Beyond the center detent position (unity gain), these controls give you up to 15 dB gain, which should be more than enough to drive any effects unit. The SOLO buttons [38] enable you to monitor the Aux signals via the MON OUTput [75]. When the SOLO function is on, its control LED lights up (for Aux Sends 1, 3, 5 or 2, 4, 6).

### 2.4.2 Aux Returns – additional stereo line inputs

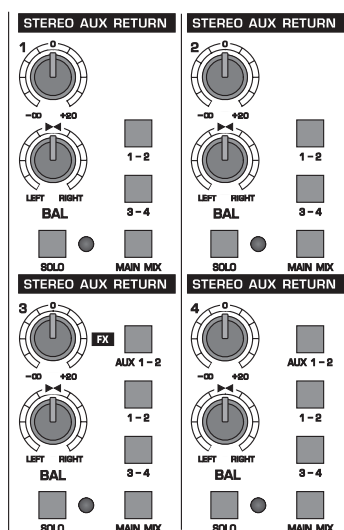

Fig. 2.12: Aux Return Main section

Your EURORACK MX3242X offers four effect returns on ¼" phone jacks ([84], [83], [82] and [81]). When you connect the left jack only (except Aux/FX Return 3), the corresponding Aux Return is automatically set to mono (signal on left and right channel).

These inputs have a BALANCE [42] / [47] and a LEVEL control [41] / [45]. Like the Main input channels, Aux Returns 1 and 2 can be routed [40] to the Main Mix and the four Subgroup buses. Aux Return 3 (FX Return) is normally used to return the effect signal from the on-board Effects Processor. However, when you use its phone jack inputs [82], you can configure it as an additional stereo line input. Aux Returns 3 and 4 can additionally be routed to the Subgroup and Main Mix buses, for example to add reverb to the monitor mix sent to a singer, which can be done most conveniently with the on-board effects processor.

Naturally, all Aux Returns feature a SOLO function (plus control LED) which can be activated with the SOLO button [43] / [48].

Aux Returns not only accept the output signal of an effects device, they also serve as versatile stereo line

inputs. For example, they can return the signal of a multi-track recorder (Tape Returns), or act as inputs for instruments, especially when your MIDI keyboard or rack delivers a pre-mixed stereo signal.

### 2.4.3 Level meters

The Main Mix / PFL / SOLO level is displayed by two highly accurate 8-segment peak meters [53]. Depending on the status of the SOLO function, either the PFL [54] or SOLO LED [55] lights up.

### 2.4.4 CHANNEL MODE and SOLO MASTER LEVEL controls

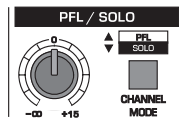

Fig. 2.13: PFL/SOLO Main section

The CHANNEL MODE button [35] determines whether PFL (pre-fader listen) or Solo-In-Place is assigned to the SOLO buttons in the channels. With the LEVEL control [36] you can set the master volume of the PFL/SOLO function. We recommend that you set this control to 0 dB, i.e. 12 o'clock. In loud environments (e.g. live application), you can of course raise the PFL/SOLO volume as required.

#### PFL

PFL should always be used for gain setting (see also chapter 3 PRACTISE). Here, the signal is always taken pre-fader and routed to the mono PFL bus.

#### SOLO

Pressing button [35] once deactivates the mono PFL bus and replaces it with a separate stereo SOLO bus. SOLO is short for Solo-In-Place, and is the preferred method for auditioning an isolated signal, or group of signals. Whenever a SOLO button is pressed, all unselected channels are muted in the monitors. Stereo panning is maintained. The SOLO bus is derived from the output of the channel Pans, Aux Sends and stereo Line inputs. The SOLO bus is always post-fader.

### 2.4.5 Mix-B

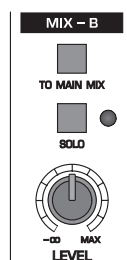

Fig. 2.14: Mix-B Main Section

The LEVEL control [58] allows you to adjust the overall volume of the Mix-B bus, and the button TO MAIN MIX [56] routes the Mix-B bus to the Main Mix bus. Thus, you can configure your MX3242X as a 32-channel console. As the Mix-B input channels are specifically designed for line-level signals, they are ideally suited for returning the signals from effects and MIDI devices. Naturally, the Mix-B bus also has a SOLO function, which can be activated with button [57]. In this case, the button's associated LED lights up.

## 2.4.6 Monitor section

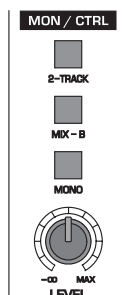

Fig. 2.15: Monitor section

The buttons 2-TRACK [63] and MIX-B [64] determine which signal is sent to the MON OUTputs [75], where you can connect active or passive speakers (plus power amp). If neither one of the buttons is pressed, the outputs provide the Main Mix signal. The 2-TRACK button allows you to monitor the signals from a 2-Track master recorder (e.g. DAT). When you connect its input [76] to a hi-fi amplifier featuring a source selector, you can conveniently monitor other sources, too (e.g. cassette recorder, CD player, etc.).

We recommend that you use more than just one single pair of speakers! Rather, you should connect at least half a dozen of different (matrix-networked) speaker pairs – from ghetto blasters, car and club systems to broken 5-cm portable-radio speakers mounted in a cardboard carton!

Use the LEVEL control [66] to set the volume of the monitors.

The MONO button [65] allows you to check that stereo signals are mono-compatible.

 **All buttons are effective on the monitor output only. They will not affect the Main Mix signal delivered by the Main outputs.**

## 2.4.7 Headphones section

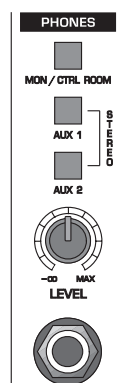

Fig. 2.16: Headphones section

The headphones jack [62] accepts any commercial studio headphones. With the buttons MON/CTRL ROOM [59], AUX 1 and AUX 2 [60], you can select the source for the headphones signal, while the LEVEL control [61] determines the volume level.

When the MON/CTRL ROOM button is pressed, the headphones output delivers the signal selected in the MON/CTRL section. Press one of the two AUX buttons to monitor the Aux Send signal on both sides of your headphones. To create a stereo headphones mix, just press both AUX buttons. Now the signals from Aux Sends 1 and 2 are routed to the left and rights side of your headphones respectively.

 **Please note that too high a monitoring level can lead to hearing damage.**

### 2.4.8 Subgroups and Main Mix fader

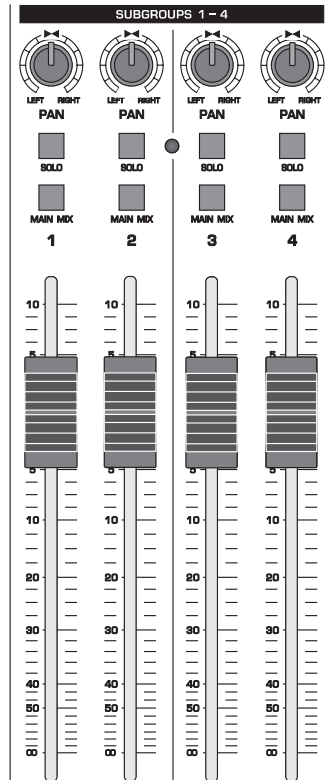

Fig. 2.17: Subgroups section

In a recording situation, the inputs of a multi-track recorder are fed with signals from the Subgroup outputs [78]. The 4 Subgroups, in turn, can be fed by the Main input channels and the Aux Return buses. In this way, you can also record effect signals. The faders [52] control the level of the signals routed to each Subgroup, while the MAIN MIX button [51] sends the signal routed to a Subgroup back to the Main Mix bus. Use the PAN control [49] to determine the signal's position in the Main Mix stereo field. When the MAIN Mix button is up, the PAN control has no influence on the Subgroup signals.

In live applications, Subgroups are often used to combine various groups of instruments and control their volume with one or two (stereo mode) faders. The Subgroups' insert points allow for processing multiple signals with just one device (e.g. Compressor). The SOLO button [50] and its associated control LED enable you to monitor each of the 4 Subgroups individually.

The MAIN MIX fader [69] determines the level that is sent to the MAIN OUTPUTS, which are available both on 1/4" phone jacks [72] and XLR connectors [71]. The MX3242X also routes the MAIN MIX signal to the 2-TRACK-OUT cinch jacks [77].

### 2.4.9 Digital Effects Processor

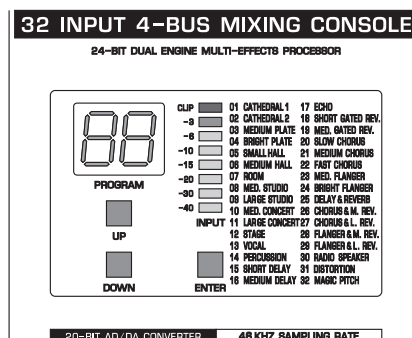

Fig. 2.18: Digital effects module

A very special feature of your MX3242X is its on-board Effects Processor, which offers the same hard/software quality as our well-known 19" VIRTUALIZER DSP1024P. This effects module provides 32 different standard effects such as Reverb, Chorus, Flanger, Delay, Pitch Shifter and various effects combinations. Use Aux Send 3 (Main input channels) and the Aux Send 3 master control to feed signals to the Effects Processor. Please make sure that the level read by the LED level meter [29] in the effects module section is always high enough. However, the CLIP LED should never light up.

The two buttons UP [31] and DOWN [32] select a specific preset. To speed up preset selection, you also need to press the respective opposite button. Then, you can activate the selected preset with the ENTER button [33]. The display [30] reads the number of the currently active preset. Its name can be found in the preset list printed next to the LED level meter.

Aux Return 3 allows you to assign the effect signal to the Subgroups and Main Mix bus. Additionally, you can use the Effects Processor for your headphones mix by routing Aux Return 3 to Aux buses 1-2.

No.	Preset name	No.	Preset name
1	Cathedral 1	17	Echo
2	Cathedral 2	18	Short Gated Reverb
3	Medium Plate	19	Medium Gated Reverb
4	Bright Plate	20	Slow Chorus
5	Small Hall	21	Medium Chorus
6	Medium Hall	22	Fast Chorus
7	Room	23	Medium Flanger
8	Medium Studio	24	Bright Flanger
9	Large Studio	25	Delay & Reverb
10	Medium Concert	26	Chorus & Medium Reverb
11	Large Concert	27	Chorus & Large Reverb
12	Stage	28	Flanger & Medium Reverb
13	Vocal	29	Flanger & Large Reverb
14	Percussion	30	Radio Speaker
15	Short Delay	31	Distortion
16	Medium Delay	32	Magic Pitch

Tab. 2.1: Effect presets provided by on-board effects module



**Cathedral:** A very dense and long Reverb, much like that heard in great cathedrals. Particularly suitable for solo instruments or voices in slow songs.

**Plate:** The sound of early Reverb plates. A classic Reverb program for drums (snare) and vocals.

**Room:** You can clearly hear the walls as they are reflecting the sound. A useful program for “inaudible” Reverb (rap, hip hop vocals) or to make dry recordings of instruments sound natural again.

**Studio:** This versatile room simulation program generates a very natural ambiance.

**Concert:** Here, you can create a small theater (**Medium Concert**) or large concert hall (**Large Concert**), which are more lively and brilliant than the “Studio” reverb.

**Stage:** A wonderful Reverb, for example, to give keyboard pads or acoustic guitars more width and depth.

**Vocal:** Rich and dense Reverb with middle Reverb times which gives vocals or other solo instruments their finishing touch and makes them an integral part of the mix.

**Percussion:** This dense Reverb is characterized by pronounced early reflections which make it a natural choice for dynamic signals (drums, percussion, slap bass, etc.).

**Delay:** This program applies several repetitions or echoes to the delayed input signal.

**Echo:** Much like the Delay effect, echo repeats the input signal with decaying intensity. However, here the echoes lose brilliance with each repetition, which simulates the trendy “vintage” effect produced by tape echo units that were widely used in the pre-digital era.

**Gated Reverb:** Phil Collins’ song “In the air tonight” made this effect famous: a Reverb is cut off abruptly after a certain time.



**Flanger:** An LFO constantly modulates the effect signal’s pitch by a few cents up and down. Flanger effects are primarily used for guitars and electric pianos, but there are lots of other useful applications: voices, cymbals, bass, remixes, etc.

**Chorus:** Though similar to the Flanger, Chorus uses a delay function instead of feedback. Combined with the pitch shifting feature, the delay produces a very pleasant detune effect. Chorus effects are used so frequently and in such a variety of applications that any recommendation would mean a limitation of their use.

**Pitch Shifter:** This effect transposes the input signals to create musically useful intervals and harmonies or simply to widen the sound of a single voice. Heavy pitch shifting can also be used to produce a Mickey Mouse type voice effect.



**Delay & Reverb:** Probably the most popular combination used for vocals, solo guitars, etc. The program employs a Bright Room reverb which can be used for a great variety of applications.

**Chorus & Reverb:** This algorithm combines a popular chorus effect with a Reverb.

**Flanger & Reverb:** Flanger effect combined with a Reverb.



**Radio Speaker:** Simulates the typical sound of a portable radio: lots of midrange, poor bass and treble.

**Distortion:** Absolutely modern effect for vocals or drum loops, combined with a Delay effect. Special feature: this distortion algorithm also has an LFO-controlled notch filter included.

#### 2.4.10 Talkback facility: communicating with performers in the studio

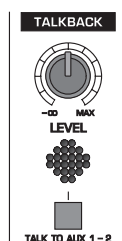

Fig. 2.19: Talkback section

The built-in Talkback microphone enables you to communicate with the performers in the recording room, on stage or via headphones. Use the buttons TALK TO AUX 1-2 [68] to activate the microphone and access Aux Sends 1 and 2. The volume of the talkback facility can be determined with the LEVEL control [67]. To avoid feedback in the monitors (e.g. when SOLO-ing Aux Buses 1 and 2), the level at the monitor output is reduced by 20 dB, as long as you press the TALK TO AUX 1-2 button. Of course, the Main Mix bus remains unaffected by these operations.

### 3. PRACTISE

#### 3.1 Selecting inputs

- 1) Mono channels accept Mic or Line inputs. If you are using the Mic input, make sure nothing is connected to the Line input (and vice versa).
- 2) Mic inputs are more sensitive than Line inputs. Do not connect microphones with Phantom Power switched on.

#### 3.2 Initializing channels for gain setting

- 1) Set gain to minimum in all Main input channels, and all Aux Sends to OFF (fully counterclockwise).
- 2) Set EQ to flat (all controls at 12 o'clock) and turn it off (EQ IN button up).
- 3) Set the LO CUT button to OFF, unless you need the frequencies below 75 Hz (18 dB/Oct., -3 dB).
- 4) Set CHANNEL MODE to PFL and LEVEL to 12 o'clock for SOLO function.
- 5) Press the PFL/SOLO button in the channel you wish to adjust.

#### 3.3 Auditioning a signal and setting up a channel

- 1) Make a typical noise, or roll the tape. The peak meter should read a PFL level.
- 2) Main input channels: Adjust the Gain control until transient peaks are regularly hitting +10 dB. Continuous signals should not exceed 0 dB.
- 3) If EQ is used, repeat steps 1) & 2).
- 4) If an insert is used to patch in a Compressor, Gate, Equalizer, etc., use the outboard processor's Bypass or Effect Off switch to A/B monitor the effect. If it does not have a bypass switch or equivalent, you will have to keep connecting and disconnecting the device until you complete the following procedure: adjust the processor's output level so that effected and bypassed signals are of comparable level, i.e. unity gain.
- 5) Route the channel as desired, then switch off all PFL/SOLO buttons. Now set up the next channel.

#### 3.4 Desk normalization

All board settings should be set to the normal default conditions before or after every session. Usually, faders are set to zero (minus infinity), EQ's set flat and switched out, Aux Sends turned fully counterclockwise, etc.. Many controls have a natural initial setting. For EQ cut and boost this is center position. However, some settings, such as selecting PRE or POST for channel Aux Sends, will depend on the operating environment (e.g. studio or live), or on a particular engineer's preferred way of working.

#### 3.5 Multi-track initialization

Set up the multi-track recorder so that any track in "record ready" condition has its input monitored when the tape is stationary (once a recording has been made, these tracks should automatically switch to tape playback). Check that the input levels to each track are optimized before recording commences.

#### 3.6 Recording levels

When recording to digital, it's a good idea to keep the recorder's peak meters below 0 dB. Most (not all, especially samplers) read 0 dB with some headroom left. This is because, unlike with analog, the onset of digital distortion is as sudden as it is horrible. If you really want to take your recording level to the limit (and fully exploit the 16-bit digital's 96 dB dynamic range), you'll have to do some calibrating. How to do it? Well, you could run a tone at 0 dB from the mixer and use that as your DAT reference. But your DAT may be way under its maximum input limit. Probably a better way to work out just how hard you can drive your recorder is

to incrementally increase the record level until the onset of digital distortion, subtract, say 5 or 10 dB, and never exceed that level. Engage “peak hold” on your recorder before recording if you want to confirm that you haven’t.

When recording to analog, the tape machine’s VU meters should show around +3 dB on bass, but only around -10 dB for hi-hats. Although analog distortion is more like compression at modest overload levels (often desirable on bottom end), higher frequencies cause saturation even at modest levels (an unpleasant “crunchiness”). Also, VU meters tend to progressively under-read above 1 kHz, due to their sluggish response time. Hi-hats should read about -10 dB on a VU meter, as against 0 dB for a typical snare drum, and +3 dB or more for a kick drum.

Peak meters read more or less independent of frequency. Aim for 0 dB recording level for all signals.

### 3.7 Track sheet

When laying out channels for recording or mixing, try to be sensible. Keep tom-toms together, always use the same channels for kick drum, snare, hi-hat, bass, etc. After some time, you will know where you are without hardly ever having to look at a track sheet (which is still a good idea to be able to figure out channel assignments even after years).

On the lower part of the console’s panel you can attach a strip of tape on which to make notes of which instrument is assigned to which channel. Please remember to remove the tape after the session, so as to avoid traces of glue remaining on the console.

## 4. APPLICATIONS

Using several examples, this chapter explains how to wire and use your MX3242X in typical studio and live applications.

### 4.1 Recording situation

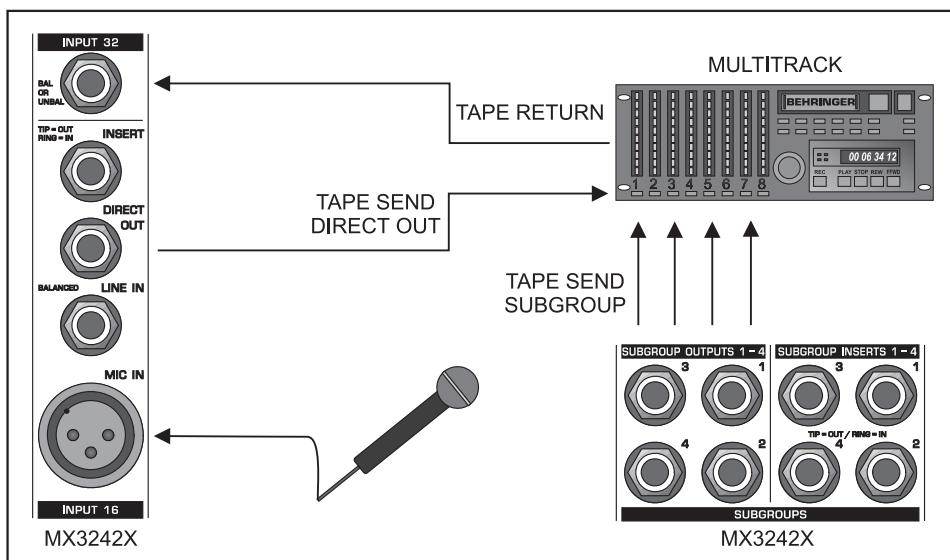



Fig. 4.1: Recording situation: example of typical connection scheme

In a typical recording situation the instruments or voices to be recorded are directly connected to the main input channels of the console, using microphones (vocals, guitar amp, wind instruments, drums, etc.) or line outputs (keyboards, sound modules, samplers, etc.). Ideally, this is done with a wall box mounted in the studio (recording room) and connected to the Main input channels of the MX3242X set up in the monitor room. In this configuration, the audio signal passes through the channels and is routed to the multi-track recorder (Tape Send), either via the Subgroups or the direct outputs. It should be made sure though that the Main Mix routing buttons are not pressed. Subsequently, the signal is sent back from the multi-track machine to the



Mix-B inputs (Tape Return). Please select monitor bus Mix-B in the MON/CTRL section, so that you can control the tape return signals using the LEVEL and PAN controls of the Mix-B input channels.

 **In a recording situation the recorded material should always be monitored via the Tape Return bus.**

The same applies to the monitor mix and effect sends for the performing musician(s); they, too, should be fed from the Tape Return bus. Press both SOURCE buttons in the Aux Send section as well as the PRE button of Auxes 1 & 2. Now, you can create a monitor mix using Aux send 1 and/or Aux send 2, and send the effects via Aux send 3 through 6 (press the SHIFT button to use Aux Sends 5 and 6). If you wish to use the on-board effects processor, you should press the routing button AUX 1-2 in the Main Aux Return 3 section, so as to route the effect signal directly on the monitor mix controlled with Aux Send 1 and/or 2.

 **In a recording situation both monitor mix and effect sends should always be assigned to the Tape Return bus.**

## 4.2 Live situation

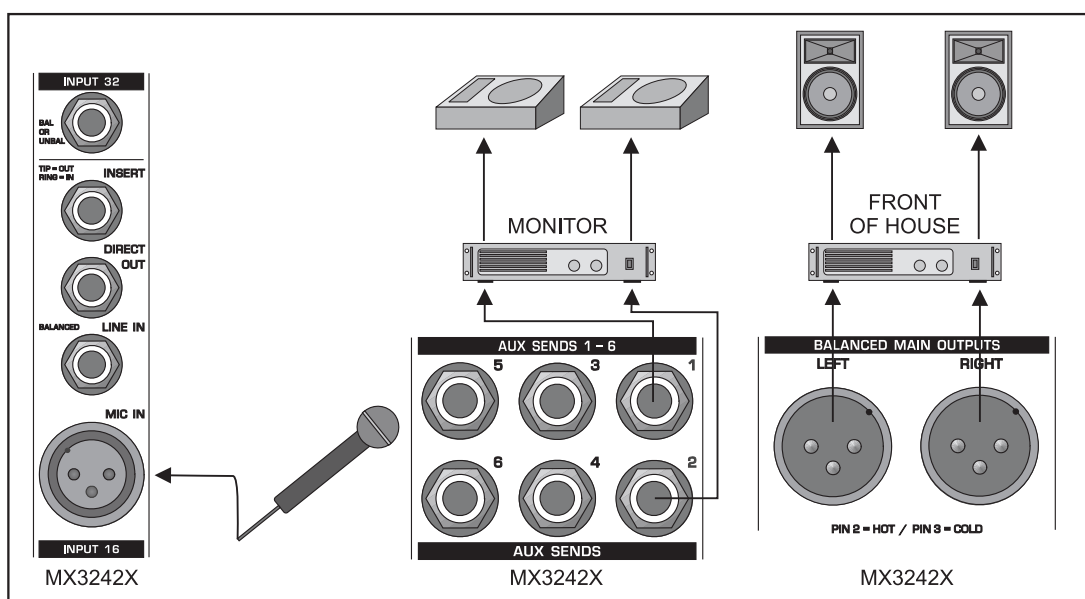

*Fig. 4.2: Live situation: example of typical connection scheme*

For live applications all instruments are connected to the Main input channels. Since the Mix-B input channels are not used for the Tape Return bus (as in the studio), these inputs can be used for keyboards, sound modules, etc. It should be noted though that the TO MAIN MIX button in the Mix-B Main section must be pressed and the LEVEL control for the Mix-B bus set to 12 o'clock. The Main Mix outputs feed the power amps of the P.A. system. Therefore, the buttons 2-TRACK or MIX-B in the MON/CTRL section should be up, so that you can monitor the Main Mix bus. Aux Sends 1 & 2 are used to feed the monitor system and should therefore be set pre-fader. These Aux Sends derive their signals from the Main input channels (SOURCE button up); all effect sends are assigned to Aux Sends 3 through 6.

If two monitor paths are not enough, you can also use the Mix-B bus as a stereo monitor bus, for example to drive two side-fill speakers. For this purpose, press Mix-B channel's SOURCE button. Make sure that the TO MAIN MIX button in the Mix-B section is up (not pressed); otherwise, the monitor mix would also be sent to the FOH system.

The Subgroups can be used to create, for example, a sub-mix of all drum instruments. In this way, you can control the overall level of the drums with just two faders.

In a live situation, the vocals are often not loud enough and can't make themselves heard, even though they may be processed with Compressors or their faders may be fully up. If you have a Subgroup with no signals assigned, you can route the vocals to this Subgroups and adapt their levels there.

If you consider using dynamic processors, you should patch these devices to the Subgroup inserts. As the

Main input channels are most often used for the monitor mix, a Compressor in the channel insert would raise the signal level in soft passages and induce feedback in the monitor system.

### 4.3 Patchbay

A Patchbay allows to patch the audio signals of most components in your studio from a central point and send them to other units, which makes your entire cabling better structured and is indispensable for professional work. If you want to use your studio as effectively as possible then it is preferable to use a complete Patchbay wiring scheme, but even less sophisticated patchbay solutions will benefit smaller studio configurations.

#### 4.3.1 Patchbay configuration

The majority of commercially available Patchbays include two rows with 24 phone jacks each in a 19" 1 HU rack panel. On the rear, either a corresponding number of phone jacks or contacts for soldering signal leads can be found. Each group of four of these phone jacks forms one module. The configuration of some Patchbays can be changed by inserting jumpers or turning individual modules.

With the help of our ULTRAPATCH PRO PX2000, an easy-to-use 24-Patchbay offering phone jacks throughout, you can easily understand the four different modes. With the ULTRAPATCH PRO you can select between the four different operating modes simply by setting a switch on the upper panel (example: module 17).

#### 4.3.2 Parallel

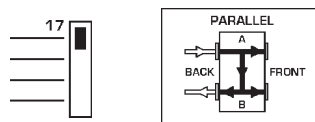

Fig. 4.1: Patchbay mode "parallel"

In this mode, all terminals of one module are interconnected. This configuration doesn't make sense at first glance but is used to split up and send *one* audio signal (e.g. Aux Send) to several destinations (e.g. effects devices).

#### 4.3.3 Half-normalled

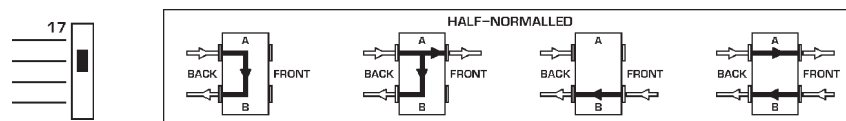

Fig. 4.2: Patchbay mode "half-normalled"

In this configuration, the contacts of the two jacks on the rear are interconnected. When you insert a plug into the upper front jack, the signal routed through the rear path is not interrupted. Only when the lower front jack is used will the rear panel route be split up, so that the two upper and the two lower phone jacks are connected to one another. This configuration is called "input break" and is used mainly for insert paths. So you can easily patch the signal from a mixing console channel at the Patchbay without interrupting the signal flow in the channel.

4.3.4 Normalled

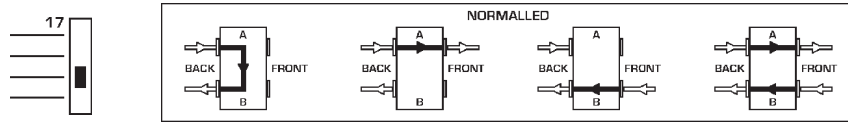

Fig. 4.3: Patchbay mode “normalled”

Here, and in contrast to the “half-normalled” setup, the signal route of the rear phone jacks is interrupted when you insert a plug both into the upper and lower front jacks.

4.3.5 Open

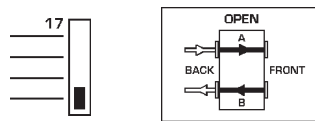

Fig. 4.4: Patchbay mode “open”

This mode is used to connect devices such as sound modules or CD players having no inputs of their own. This saves space, as you can route the left and right outputs to one module (left - top; right - bottom) or patch two devices to one module (top and bottom). Effects devices and 2-Tracks can be configured this way, so the inputs and outputs are positioned on top of each other.

Basically, the inputs are routed to the bottom and the outputs to the top rear-wall connectors. Avoid routing digital signals over a Patchbay as the pulse signal used for the transmission of such signals causes heavy interference in analog signals. Additionally, normal Patchbays change the impedance of the digital cable route, which causes interference in the digital path. Use the BEHRINGER ULTRAMATCH SRC2000 specifically designed for this and other digital signal-related functions.

Microphone inputs operate at a level several orders of magnitude lower than Line levels (+4 dBu or -10 dBV). Therefore, they should never be routed via a Patchbay. In any case, patching in a field with 48 VDC (Phantom Power) flying about is to be avoided at all costs. It is best to plug mics directly into the mixing console or via special XLR-type wall boxes connected to the Mic inputs of the console by good-quality balanced multicore cables (2-cond. + shield).

4.3.6 Patchbay organization

Let us give you an example configuration that shows how you can most effectively use your Patchbays. We assume you own a mixing console with 16 Mic/Line inputs plus inserts, 8 Direct Outputs, 8 Subgroups with 4 inserts, 4 Aux paths with 2 stereo Returns and one stereo master output including insert jacks. Added to this we have an 8-track recorder (digital or analog), a few pieces of outboard equipment (FX, Dynamics & EQ's), a CD player, tape deck, HiFi system and a headphones amp:

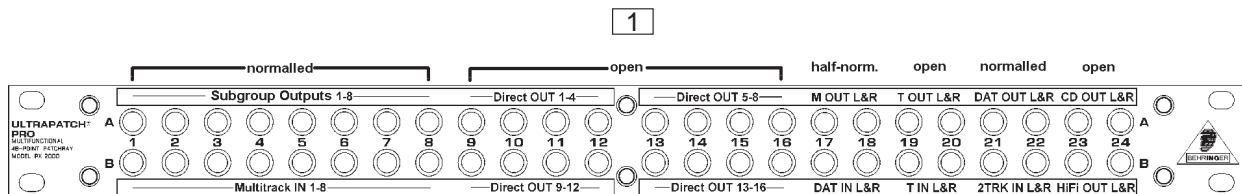

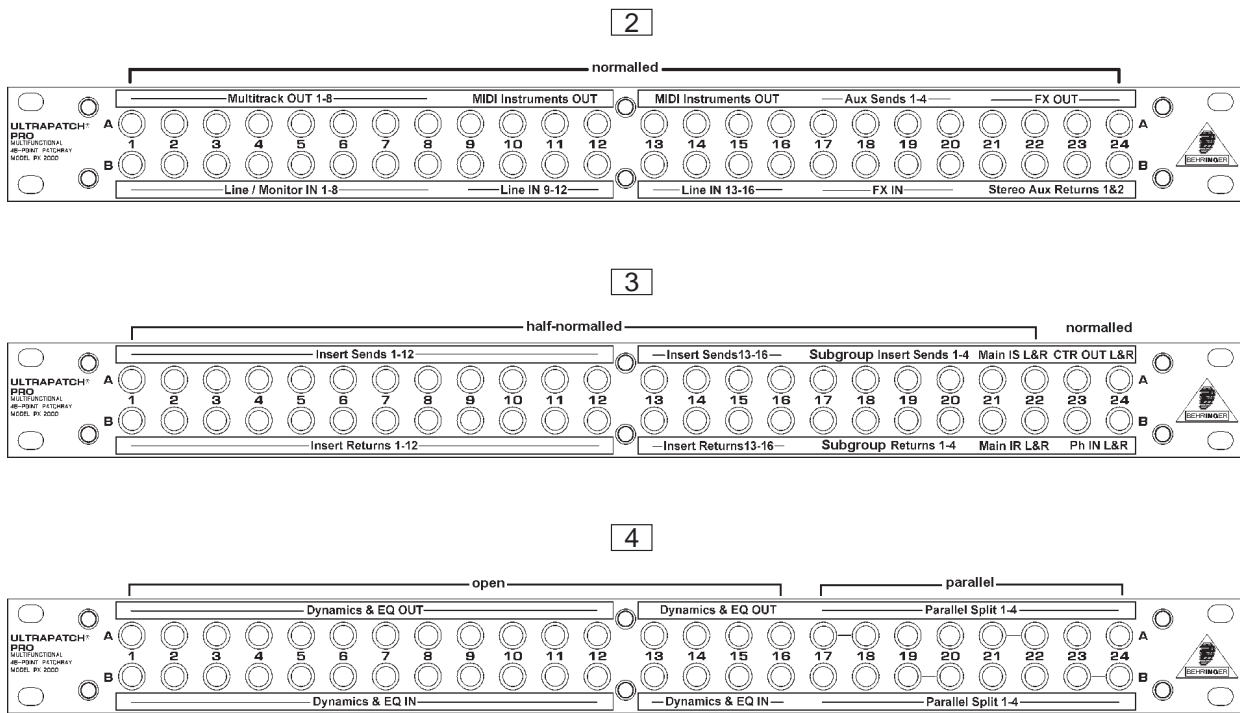

Fig. 4.1: Example of a studio organization with four Patchbays

In the first eight modules of Patchbay **1** the Subgroup outputs are directly connected to the corresponding multitrack inputs. In addition to that it is also possible to record the signals coming from a Subgroup on a different track of the multitrack. To save space and provide a clearly structured configuration, the Direct Outputs are connected both to the top and bottom jacks. Modules 17 & 18 are the stereo master output, which is half-normalled and thus allows for recording both to the DAT recorder and the tape deck, simply by patching it accordingly. Modules 19 & 20 (tape deck) are open, because it does not make sense connecting the inputs and outputs of the tape deck. 21 & 22 are normalled and route the DAT recorder outputs to the 2-Track-ins of the mixing console. So it always is possible to control the recorded data on the 2-Track from the mixing console. The CD player and the HiFi system are connected to modules 23 & 24, which are open, because they only serve as a source.

In Patchbay **2** the first 16 modules are normalled (1 through 8 IN could also be used to connect the corresponding monitor inputs – if the console has a separate monitor section). MIDI devices such as samplers, expanders, keyboards, etc. are usually set up in every corner of the room. To make the cabling better structured we route these units to modules 9 through 16. This allows further workmanship of the MIDI devices at the mixing console. Modules 17 through 20 are normalled and have the FX inputs and the Aux Sends connected, 21 through 24 are also normalled and are patched to the two stereo Aux Returns with the FX outputs.

In patchbay **3**, modules 1 through 16 are for the channel insert. These modules are half-normalled, so that you have an additional route for the channel signals. The same applies to the insert paths of the Subgroups and the master output. The headphones amp is connected to 23 & 24, which are normalled and connected to the Control Room outputs of the mixing console. Of course, you can also use pre-fader Aux paths for the headphones mix.

Patchbay **4** manages the dynamics and frequency-processing devices in an open configuration (modules 1 through 16). Multigates and Compressors should be used here, in particular. Modules 17 through 24 are used to provide a “parallel split”, i.e. two modules are patched to each other on the rear with one patch cord, so that you can split up a signal applied on the front panel to several destinations. These modules have a parallel configuration.

It should be noted that Patchbays should be placed one below the other in such a way that the patch cords won't hang all over the Patchbays. In our example you don't have to span great distances, for instance, to patch the Dynamics and EQ's to the insert paths.

### 4.3.7 Looming problems

Loom wiring is an art unto itself, and it is worth taking time out to get it right. First off, it is important to avoid earth loops (a looped wire acts an aerial, picking up hum and electromagnetic radiation). Think of a tree. Every part of that tree is connected to every other part, but only by one route. That's how the total earth picture for your entire studio should look. Don't take the earth off your power cable plug to reduce audible 50 Hz mains hum. Rather you should be looking at disconnecting the signal screen somewhere (one or several audio cables).

It is good practice to ensure that all screens are commoned at the Patchbay, in which case all unearthed equipment would pick up earth from this point via a single screen (more than one route = an earth loop), while mains-earthed equipment would have all screens cut at the equipment end.

Some quality equipment has an independent signal and mains earth. In this case at least one screen should carry earth to the equipment. Sometimes the only way to find out is "suck and see".

Take care to ensure that using the Patchbay does not disturb the studio's earth architecture. Always use short as possible patch leads with the screen connected at both ends.

Having designed mains hum out of the system, make up your cable looms from the Patchbays outwards, and use cable ties, flexible sheaths, multicores, etc. to keep the back of your racks tidy.

## 4.4 Expanding the MX3242X

When the EURORACK is your main mixer, you may find that you run out of inputs as your system expands. It is possible to expand your mixing system by combining two or more mixers.

### 4.4.1 Expander Port

The easiest way to expand your MX3242X is to connect another MX3242X or additional modules (such as our RX1642 which will be available soon). The BEHRINGER RX1642 is a 19" 1 HU Line mixer which provides 8 stereo inputs on balanced ¼" phone jacks. The signals passing through the RX1642 can be routed both to the Subgroups and to the Main Mix bus. With its Main Mix outputs, the RX1642 can also be used as a separate Line mixer. One of its special features is an EQ integrated in the Main Mix section, which allows you to process signals independently of the MX3242X.

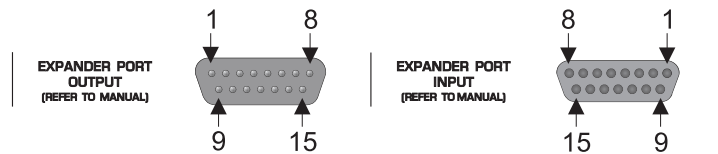

Fig. 4.8: Expander Port connectors

To link several consoles simply connect the Expander Port output to the Expander Port input of the next console. The last console in the chain acts as master mixer. This last console controls all Aux Send, Subgroup, Mix-B and Main Mix signals of the other linked mixers.

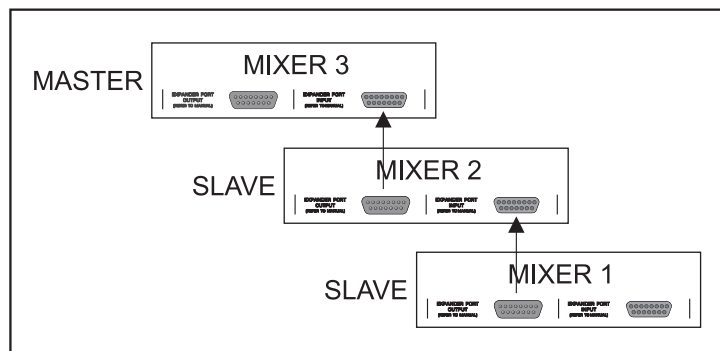

Fig. 4.9: Connecting several consoles via their Expander Ports

With the Expander Port inputs [92] and outputs [91] of your MX3242X you can route the following buses to the outside world, and feed in the following external signals:

PIN-NO.	DOCK INPUT	DOCK OUTPUT
1	AUX SEND 1	AUX SEND 1
2	AUX SEND 3	AUX SEND 3
3	AUX SEND 5	AUX SEND 5
4	SUBGROUP 1	SUBGROUP 1
5	SUBGROUP 3	SUBGROUP 3
6	GND	GND
7	MIX-B L	MIX-B L
8	MAIN MIX L	MAIN MIX L
9	AUX SEND 2	AUX SEND 2
10	AUX SEND 4	AUX SEND 4
11	AUX SEND 6	AUX SEND 6
12	SUBGROUP 2	SUBGROUP 2
13	SUBGROUP 4	SUBGROUP 4
14	MIX-B R	MIX-B R
15	MAIN MIX R	MAIN MIX R

*Tab. 4.1: Assignment of Expander Port inputs/outputs*

#### 4.4.2 Modifications

The modifications described below require some soldering skills, and should therefore be attempted only if you have sufficient experience in soldering. If in doubt, please contact an electronics expert.

 **Please note that any one of the modifications listed below will void your warranty rights.**

The pc boards (2 boards, each with 8 mono and 8 Mix-B input channels) can be accessed when you remove the entire bottom panel of your MX3242X. One board each is used for channels 1 through 8, and 9 through 16. The two boards are identical and labeled the same.

The ends of the jumpers to be soldered in should not be inserted into the holes, but soldered flat to them! Bend the jumper a little bit up between the two points of rest. A wire with plastic insulation stripped off at the ends will work fine!

J1 - J8 →  
 J9 - J16 →  
 J17 - J24 →

J25 - J32 →

J33 - J40 →

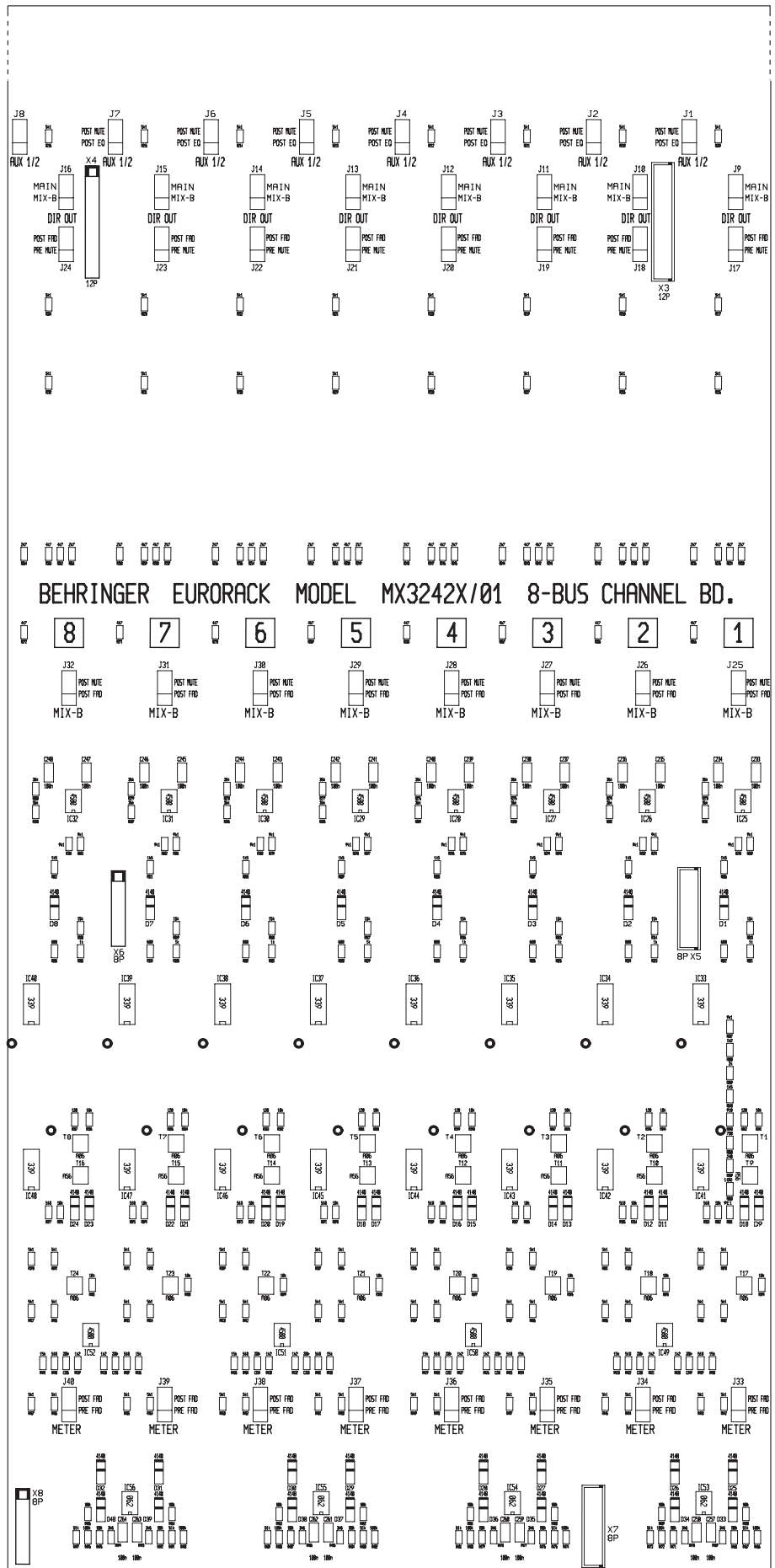
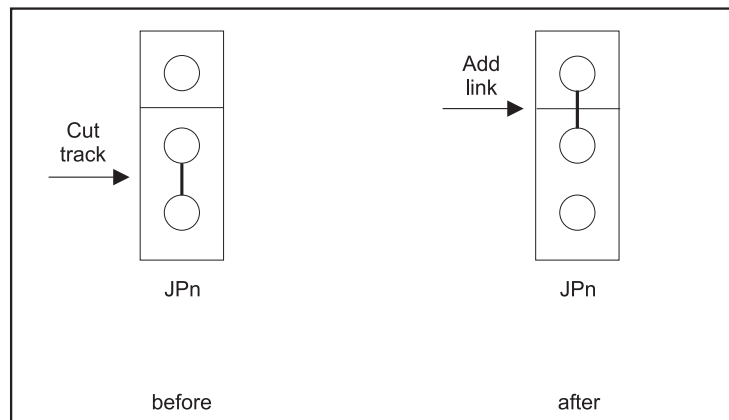

Fig. 4.10: Partial view of pc board carrying 8 mono and 8 Mix-B input channels

**Here's how to do it:**

- 1) Switch off the mixing console and disconnect it from the mains!
- 2) Cut the existing pcb track.
- 3) Solder a new jumper.



*Fig. 4.11: Cut pcb track and solder jumper*

**J1 through J8: changing Aux Send 1/2 from POST MUTE to POST EQ.**

When Aux Send 1/2 is set pre-fader (PRE button pressed), the signal is taken post-MUTE, but pre-fader. Advantage: during a live gig you can easily mute the channels not in use as well as the monitor path. In a recording environment it is often desirable that performing musicians can hear themselves in the monitor mix, even though the MUTE button in the respective channel may be pressed. In this case, change Aux Send 1/2 to POST EQ.

**J9 through J16: changing direct out signal from Main input channel to Mix-B.**

Normally, the direct output carries the Main input channel's signal, so that more than 4 tracks can be recorded at the same time. However, to realize a live set-up with simultaneous multi-track recording, you cannot use the direct outputs. As these are set post-fader, the multi-track machine would also record any changes of fader settings (which are inevitable during a gig). In this case, the console should be modified. Then, press the SOURCE button in the Mix-B channels, so that they carry the same signals as the Main input channels. Now the LEVEL controls of the Mix-B channels determine the levels sent to the multi-track recorder via the direct outputs.

With the console modified and the FLIP button pressed, the following signal flow can be achieved: instruments or microphones are connected to the mic inputs of the Main input channels, and their signals are routed to the Mix-B channels, where you can use the Mix-B LEVEL control to determine the level sent to the direct outputs. When you connect the direct outputs to the multi-track recorder (Tape Send), the Tape Returns from the multi-track machine should be routed to the Mix-B inputs. In this case, the signal passes the Main input channel, and you can use the insert, EQ and Aux buses for monitoring. Via the channel faders, Subgroups and master fader the signal finally reaches the Main Outputs. Of course you could also reverse the entire configuration: first, the signal passes the Mix-B channels to be routed via the multi-track machine to the Main input channels.

**J17 through J24: changing Direct Out from POST FADER to PRE MUTE (makes sense only if J9 through J16 are left unmodified).**

To be able to record more than 4 tracks simultaneously in a conventional recording set-up, you could use the direct outputs, and the faders to determine the levels sent to the multi-track machine. If you wish to use the direct outputs in a live situation (with the Mix-B channels employed for line-level instruments), you should consider this modification. In this case, the levels provided at the direct outputs are independent of the faders, and you can send constant levels to the multi-track machine. However, please note that EQ and gain changes during the recording should be avoided, as this will be audible on the recording tracks.

**J25 through J32: changing Mix-B Link from POST MUTE to POST FADER.**

When you press the SOURCE button in a Mix-B channel, this channel will carry the same signal as the corresponding Main input channel (e.g. Mix-B 17 has the same signal as channel 1). Since this send position does not depend on the fader setting, the Mix-B channel could be used as stereo pre-fader monitor path



(or 2x mono pre-fader monitor). If you need a stereo post-fader send, simply modify the console accordingly. Then you can, for example, drive a stereo effects device in true stereo mode.

### **J33 through J40: changing Meters from POST FADER to PRE FADER.**

When shipped from the factory, the level meters in the main input channels are set post-fader, as this is necessary for recording purposes. However, during a live gig it may be better to have the level meters read the pre-fader signal, so that you can quickly detect any level changes on stage and correct the input gain appropriately, without having to use the PFL/SOLO function. In this case, you should consider this type of modification.

## **5. TECHNICAL BACKGROUND**

### **5.1 Mixing**

#### **5.1.1 Equalization**

Few people buying a mixer will need to be told how an Equalizer works. But how to get the best out of it? Well, that's another story.

In the beginning EQ was an instrument for removing unwanted frequencies, or compensating for imperfect microphone response curves, or bumps in a studio's acoustic. It was a corrective device. Tamla Motown turned that notion upside down in the sixties with the novel idea that you try to find for each instrument a characteristic frequency not shared by the other instruments in the mix. Then you whack up its Gain. This makes individual voices punch through a mix in a slightly unnatural but exciting way.

In general corrective EQ usually involves broadband (slope) contouring, together with narrowband notching of unwanted resonances. The narrower the notch or "Q", the less the total signal will be affected.

Finding bad resonances is made easier by first frequency sweeping in BOOST mode.

"Motown" EQ is achieved by applying boost in a fairly broadband way. The broader the band, the more musical but less instrument-specific the effect. Applying boost over a narrow bandwidth will sound "honky". For sounds which require drastic corrective EQ, it is advisable to have a couple of channels of fully comprehensive Parametric Equalization in your rack. (You can always bounce tracks through the outboard EQ, freeing up the unit for the next task).

Check out the BEHRINGER ULTRA-CURVE PRO DSP8024, a superlative digital stereo Equalizer and much, much more. Or our ULTRA-Q PRO PEQ2200 5-band Constant-Q state-variable analog EQ.

For "Advanced Equalization", EQ might be applied to a signal as follows: First, trim the LF and HF shelves to achieve the required slope or "loudness". Now use a parametric EQ band to boost the most significant frequency for each instrument or tape track. Over all channels, if two or more of these frequencies coincide, then you might have to settle for second best in some cases, if you want to achieve optimum separation in the mix. Really nasty frequencies will need notching out.

A good vocal signal can be enhanced by applying a significant boost in the 12 kHz region or higher, above the nasty sibilance region. This is especially effective if you've got a De-Esser patched post-EQ.

 **Use the Lo Cut to tighten up channels in a mix: maybe remove it only for the bass, kick drum, toms, tablas, didgeridoo and other deliberate subsonics (when recording classical music ignore this advice).**

With the LF set to boost, and the Lo Cut switch activated, you have pretty much got a peak response rather than shelving at the bottom. Good for tight but deep bass.

Remember EQ contouring can be done with cut as well as with boost. Cutting away the top and bottom, then pushing up the Gain is equivalent to mid range boost! EQ is not a one way street!

Always re set a channel's input Gain (or external devices' output level) after altering the amount of desk EQ cut or boost applied.

### 5.1.2 Gain optimization

PFL (Pre-Fader-Listen) is the way to set a desk level. Master Aux Send levels are fixed at Unity Gain. As the mix progresses, more and more channels are likely to be sending to effects via the Aux buses, and it's best to PFL all sends just before setting up for the final mix.

Outboard Reverbs etc. should all be made to work hard. There's no point in having an 85 dB dynamic range if the input meter of your reverb is barely flickering. On the other hand, digital distortion is not one of the nicer noises around. You'll have to rely on your ears to detect digital distortion, since different outboard processors calibrate their meters differently.

If you hear distortion, turn down the input on the FX unit, and turn up the desk's Aux Return input.

99 times out of 100 distortion in the Aux Send > FX > Aux Return loop will come from the FX unit (FX Gain too high), and the same goes for a high noise level (FX Gain too low).

Noisy FX (or synth) Returns can be greatly improved by the addition of single-ended noise reduction between FX output and Aux (or channel) Returns. The BEHRINGER DENOISER SNR2000 is ideally suited for this purpose.

I've found that using analog single-ended noise reduction can help warm the sound of certain digital Reverbs which sound too cold/metallic, and also give that "Echoplex" sound to digital delay decays.

Analog multitrack tape should be driven quite hard, since its dynamic range (without noise reduction) is likely to be 20 to 30 dB worse than other elements in the recording chain. Try to record bright. You can always mix back duller. Brightening up an off-tape signal will bring up the level of tape noise. With digital tape or hard disk you have plenty of dynamic range, and treble pre-emphasis is not often necessary. Just don't let the signal distort!

When mixing or recording, keep the channel fader levels around or below 0 dB. If you do find the faders creeping up or down, apply a suitable offset over all channel faders, and try to control your bad habit in future!

## 6. INSTALLATION

Your BEHRINGER EURORACK MX3242X was carefully packed in the factory and the packaging was designed to protect the unit from rough handling. Nevertheless, we recommend that you carefully examine the packaging and its contents for any signs of physical damage, which may have occurred in transit.

 **If the unit is damaged, please do not return it to us, but notify your dealer and the shipping company immediately, otherwise claims for damage or replacement may not be granted. Shipping claims must be made by the consignee.**

### 6.1 Rack mounting

In the shipping carton you'll find two 19" mounting angles which can be fixed to the side panels of the console.

Remove the side panels by loosening the screws (3 per side) that fix them to the console, lay the panels aside and use the screws to fasten the mounting angles. Please note that each angle can be mounted on a specific side only.

To be able to reach the rear connectors when the MX3242X is mounted in a rack, you should rotate the interface panel by 90° (after loosening the screws holding it), and refix it. The following screws must be removed:

- 1) 4 screws on the upper part of the interface panel.
- 2) Another 4 screws on the cover plate directly mounted to the interface panel at an angle of 90°.
- 3) 6 screws each on the left and right side panels.

Once the interface panel has been rotated, please check that all ribbon cables are seated and connected properly. Then tighten all screws.

 **Ensure sufficient air space around the MX3242X. Never mount the unit in close proximity to a power amp or similar device to avoid overheating.**

-  Please note that both PSU and EURORACK will heat up during operation. This is completely normal and does not indicate a malfunction.

## 6.2 Mains connection

The mains connection of the MX3242X is made by using the included power supply unit. It meets all of the international safety certification requirements.

-  Please make sure that all units have a proper ground connection. For your own safety, it is advisable not to remove the ground connection within the units or at the supply, or fail to make this connection at all.

## 6.3 Audio connections

You will need a lot of cables for different purposes – see the following figures to make sure you have got the right ones.

Use custom-made RCA cables for the 2-Track in/out traffic (centre post = signal (+ve), sleeve = ground/screen).

It is possible to connect unbalanced sources to the balanced inputs. Use either mono jacks or connect the ring and sleeve of the jack (or pin 1 with pin 3 with XLR plugs). +48 V DC Phantom Power is also provided, which can be switched on and off with +48 V PHANTOM switch.

-  Please ensure that only qualified persons install and operate the EURORACK. During installation and operation the user must have sufficient electrical contact to earth. Electrostatic charges might affect the operation of the EURORACK!

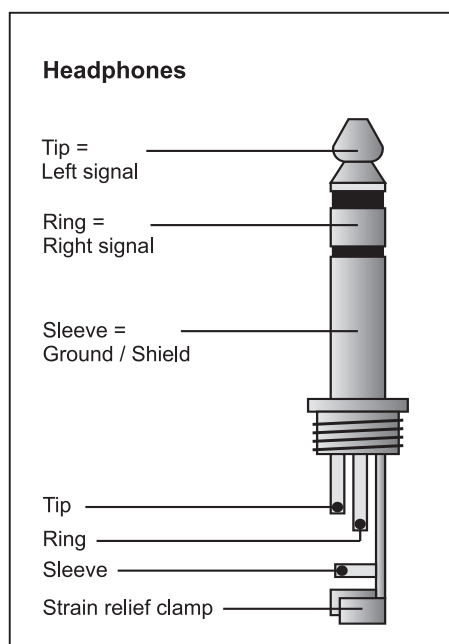

*Fig. 6.1: Headphones connector*

-  Care should be taken NOT to plug mics into the console (or stagebox) while the Phantom Power is on. Also, mute the monitor/PA speakers when turning Phantom Power on or off. Allow the system to adjust for a couple of seconds after engaging Phantom Power before setting input gains.

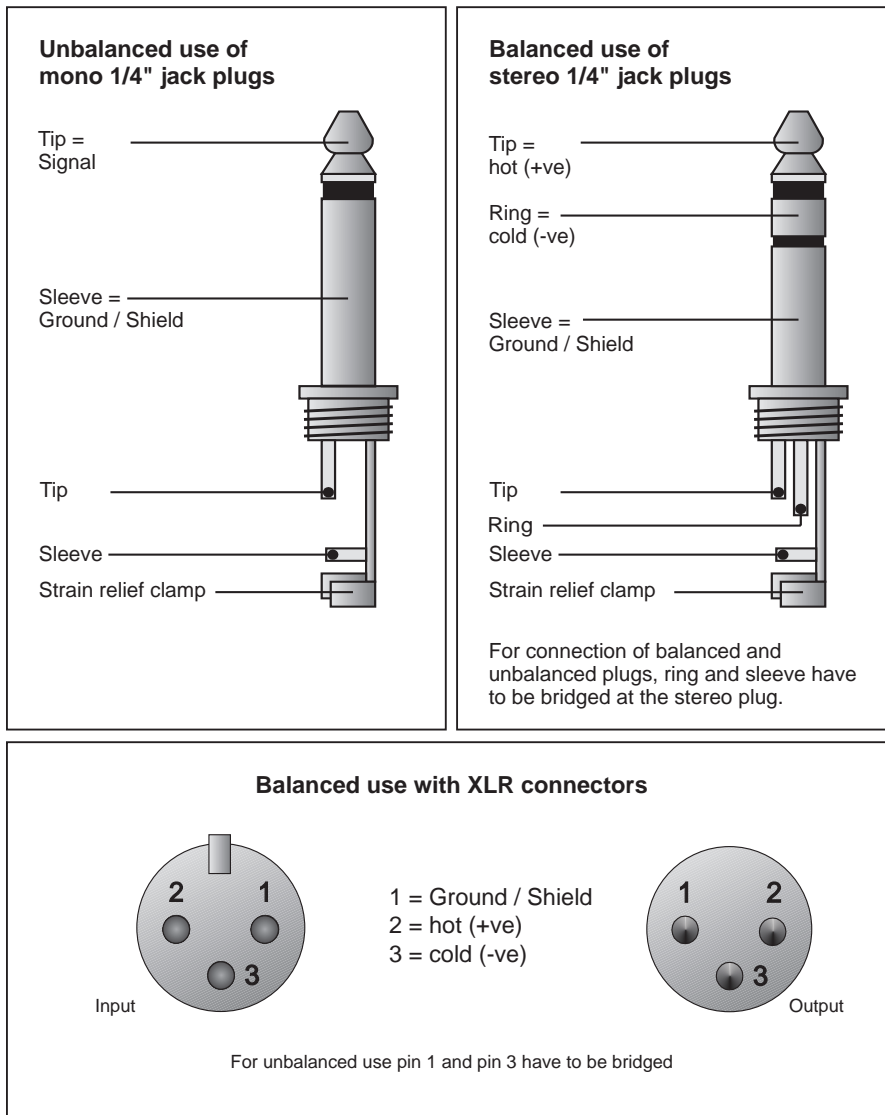

Fig. 6.2: Different plug types

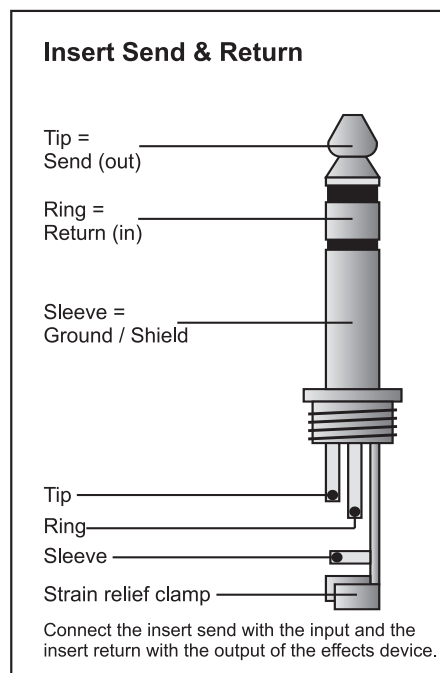

Fig. 6.3: Insert send & return connector

## 7. APPENDIX

### 7.1 Specifications

#### Mono input channels

Mic input	Electronically balanced, discrete input configuration
Frequency response	10 Hz to 130 kHz, +/-3 dB
Distortion (THD&N)	0.007 % at -30 dBu, 1 kHz, 22 Hz to 22 kHz
Gain range	+10 dB to +60 dB
Max. input	+12 dBu
S/N ratio	-125 dB, 150 Ohm source, 22 Hz to 22 kHz -121 dBqp, 150 Ohm source, 22 Hz to 22 kHz -126 dB, input shorted -122 dBqp, input shorted

Line input	Electronically balanced
Frequency response	10 Hz to 125 kHz, +/-3 dB
Distortion (THD&N)	0.006 % at +4 dBu, 1 kHz, 22 Hz to 22 kHz
Max. input	+22 dBu
S/N ratio	-97 dB, 150 Ohm source, 22 Hz to 22 kHz

Mix-B input	Electronically balanced
Frequency response	10 Hz to 100 kHz, +/-3 dB
Distortion (THD&N)	0.005 % at +4 dBu, 1 kHz, 22 Hz to 22 kHz
Max. input	+22 dBu
S/N ratio (Mix-B / Main Out)	-94 dB, 150 Ohm source, 22 Hz to 22 kHz
Channel fader range	+10 dBu to -∞ ∞

#### EQ

Low	80 Hz, +/-15 dB
Lo Mid	50 Hz to 3 kHz, +/-15 dB
Hi Mid	300 Hz to 20 kHz, +/-15 dB
High	12 kHz, +/-15 dB
Lo Cut filter	-3 dB at 75 Hz, 18 dB/oct.

#### Main Mix

Max. output	+28 dBu balanced on XLR
Aux Send max. output	+22 dBu unbalanced on jack
Control Room output	+22 dBu unbalanced on jack
Monitor output	+22 dBu unbalanced on jack
Subgroup output	+22 dBu unbalanced on jack

#### Digital Effects Processor

Converter	24-bit sigma-delta, 64/128-times oversampling
Sample rate	46.875 kHz

#### Power Supply

External Power Supply	150 Watts, 19" (482.6 mm), 2 HU (88 mm), approx. 7 kg
Mains voltage	USA/Canada 115 V ~, 60 Hz, Power Supply MX3242X-PSU-UL U.K./Australia 240 V ~, 50 Hz, Power Supply MX3242X-PSU-UK Europe 230 V ~, 50 Hz, Power Supply MX3242X-PSU-EU Japan 100 V ~, 60 Hz, Power Supply MX3242X-PSU-JP

#### Dimensions/weight

Dimensions (H * W * D, approx.)	21/22 1/2" (533,4/570 mm) * 19" (482,6 mm) * 3 3/4/9" (95,25/228,6 mm)
Weight	approx. 12 kg (without PSU)

BEHRINGER is constantly striving to maintain the highest professional standards. As a result of these efforts, modifications may be made from time to time to existing products without prior notice. Specifications and appearance may differ from those listed or shown.

## 7.2 Track sheet

Copy this model track sheet and use it to archive project-specific settings, so that you can restore a specific recording or live set-up if need be. Particularly for live applications with several groups or a series of similar concerts it can be of great help to have the required settings available. We recommend that you enlarge this page to, for example, DIN A3.

The track sheet is a comprehensive control panel for the EURORACK MX3242X 32-input 4-bus mixing console. It features 32 individual channel strips, each with the following controls from top to bottom: a gain knob, a 3-band EQ (high, mid, low), a pan knob, and a level knob. Below the channel strips are 32 master level meters. To the right of the channel strips is the main mix section, which includes a 4-digit digital display, a 20-bit A/D converter, a 48 kHz sample rate, and controls for subgroups 1-4, phantom power, pre/solo, aux sends (1-4), and stereo aux returns. The main mix section also includes a monitor/control section with a monitor knob, a talkback button, and a level knob for the main mix.

Fig. 7.2: Track sheet

## 8. WARRANTY

### § 1 WARRANTY CARD/ONLINE REGISTRATION

To be protected by the extended warranty, the buyer must complete and return the enclosed warranty card within 14 days of the date of purchase to BEHRINGER Spezielle Studiotechnik GmbH, in accordance with the conditions stipulated in § 3. Failure to return the card in due time (date as per postmark) will void any extended warranty claims.

Based on the conditions herein, the buyer may also choose to use the online registration option via the Internet ([www.behringer.com](http://www.behringer.com) or [www.behringer.de](http://www.behringer.de)).

### § 2 WARRANTY

1. BEHRINGER (BEHRINGER Spezielle Studiotechnik GmbH including all BEHRINGER subsidiaries listed on the enclosed page, except BEHRINGER Japan) warrants the mechanical and electronic components of this product to be free of defects in material and workmanship for a period of one (1) year from the original date of purchase, in accordance with the warranty regulations described below. If the product shows any defects within the specified warranty period that are not due to normal wear and tear and/or improper handling by the user, BEHRINGER shall, at its sole discretion, either repair or replace the product.

2. If the warranty claim proves to be justified, the product will be returned to the user freight prepaid.

3. Warranty claims other than those indicated above are expressly excluded.

### § 3 RETURN AUTHORIZATION NUMBER

1. To obtain warranty service, the buyer (or his authorized dealer) must call BEHRINGER (see enclosed list) during normal business hours **BEFORE** returning the product. All inquiries must be accompanied by a description of the problem. BEHRINGER will then issue a return authorization number.

2. Subsequently, the product must be returned in its original shipping carton, together with the return authorization number to the address indicated by BEHRINGER.

3. Shipments without freight prepaid will not be accepted.

### § 4 WARRANTY REGULATIONS

1. Warranty services will be furnished only if the product is accompanied by a copy of the original retail dealer's invoice. Any product deemed eligible for repair or replacement by BEHRINGER under the terms of this warranty will be repaired or replaced within 30 days of receipt of the product at BEHRINGER.

2. If the product needs to be modified or adapted in order to comply with applicable technical or safety standards on a national or local level, in any country which is not the country for which the product was originally developed and manufactured, this modification/adaptation shall not be considered a defect in materials or workmanship. The warranty does not cover any such modification/adaptation, irrespective of whether it was carried out properly or not. Under the terms of this warranty, BEHRINGER shall not be held responsible for any cost resulting from such a modification/adaptation.

3. Free inspections and maintenance/repair work are expressly excluded from this warranty, in particular, if caused by improper handling of the product by the user.

This also applies to defects caused by normal wear and tear, in particular, of faders, potentiometers, keys/buttons and similar parts.

4. Damages/defects caused by the following conditions are not covered by this warranty:

- ▲ misuse, neglect or failure to operate the unit in compliance with the instructions given in BEHRINGER user or service manuals.
- ▲ connection or operation of the unit in any way that does not comply with the technical or safety regulations applicable in the country where the product is used.
- ▲ damages/defects caused by force majeure or any other condition that is beyond the control of BEHRINGER.

5. Any repair or opening of the unit carried out by unauthorized personnel (user included) will void the warranty.

6. If an inspection of the product by BEHRINGER shows that the defect in question is not covered by the warranty, the inspection costs are payable by the customer.

7. Products which do not meet the terms of this warranty will be repaired exclusively at the buyer's expense. BEHRINGER will inform the buyer of any such circumstance. If the buyer fails to submit a written repair order within 6 weeks after notification, BEHRINGER will return the unit C.O.D. with a separate invoice for freight and packing. Such costs will also be invoiced separately when the buyer has sent in a written repair order.

### § 5 WARRANTY TRANSFERABILITY

This warranty is extended exclusively to the original buyer (customer of retail dealer) and is not transferable to anyone who may subsequently purchase this product. No other person (retail dealer, etc.) shall be entitled to give any warranty promise on behalf of BEHRINGER.

### § 6 CLAIM FOR DAMAGES

Failure of BEHRINGER to provide proper warranty service shall not entitle the buyer to claim (consequential) damages. In no event shall the liability of BEHRINGER exceed the invoiced value of the product.

### § 7 OTHER WARRANTY RIGHTS AND NATIONAL LAW

1. This warranty does not exclude or limit the buyer's statutory rights provided by national law, in particular, any such rights against the seller that arise from a legally effective purchase contract.

2. The warranty regulations mentioned herein are applicable unless they constitute an infringement of national warranty law.

---

The information contained in this manual is subject to change without notice. No part of this manual may be reproduced or transmitted in any form or by any means, electronic or mechanical, including photocopying and recording of any kind, for any purpose, without the express written permission of BEHRINGER Spezielle Studiotechnik GmbH.

BEHRINGER, EURORACK, EURODESK, POWERPLAY, ULTRAMATCH, ULTRAPATCH, ULTRA-CURVE, ULTRA-Q, DENOISER, CYBERMIX and VIRTUALIZER are registered trademarks. ALL RIGHTS RESERVED.

© 2000 BEHRINGER Spezielle Studiotechnik GmbH.

BEHRINGER Spezielle Studiotechnik GmbH, Hanns-Martin-Schleyer-Str. 36-38, 47877 Willich-Münchheide II, Germany

Tel. +49 (0) 21 54 / 92 06-0, Fax +49 (0) 21 54 / 92 06-30

---